



NEUESwagen aus LEGO®-Steinen

smarthoch3.de/moc-lego-neueswagen

Schaufenster in die Welt der Forschung

Der NEUESwagen ist buchstäblich ein Schaufenster in die Welt der Forschung, Entwicklung und Anwendung. Denn nicht nur die auffällige Gestaltung seines Äußeren verfängt. Wenige Handgriffe verwandeln das Ausstellungsregal in eine Präsentationsfläche, die dank der großen Seitenscheibe und der Beleuchtung selbst nachts noch Einblicke in die Vielfaltigkeit der Materialien gewährt.

hard facts NEUESwagen

	<i>real</i>	<i>MOC LEGO® Edition</i>
L x B x H	6.822 x 2.326 x 2.655 mm	211 x 75 x 68 mm
ZGM	2.500 kg	119,4 g
Teile	–	127 in 55 Lots
Auflage	1	250
Aufbau	~ 90 min	< 90 min

*Alle Infos zu unserem rollenden Wissenschaftsmobil
gibts unter smarthoch3.de/neueswagen*

L x B x H in Studs



Buchung anfragen



Der NEUESwagen auf Tour

Wenn Sie mögen, kommen wir (natürlich mit dem Original) auch zu Ihnen. Eine kurze Buchungsanfrage genügt und schon bald machen wir auch bei Ihnen Halt.

1

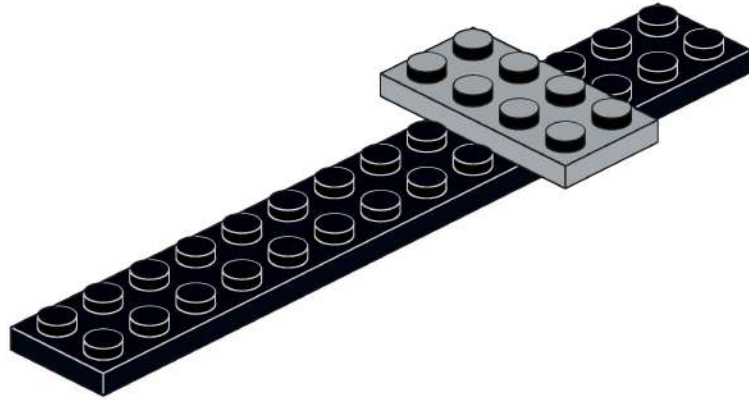
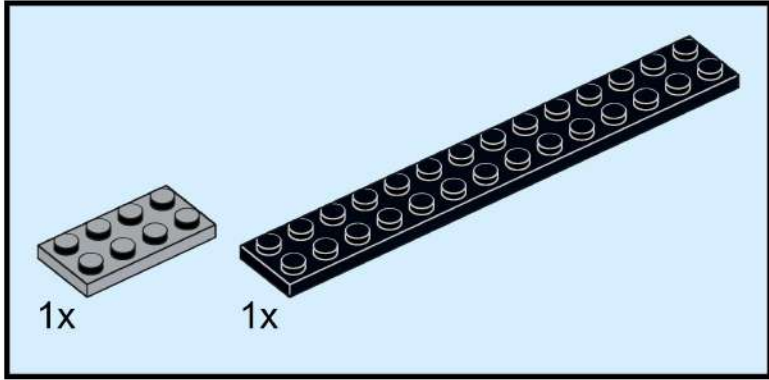

2

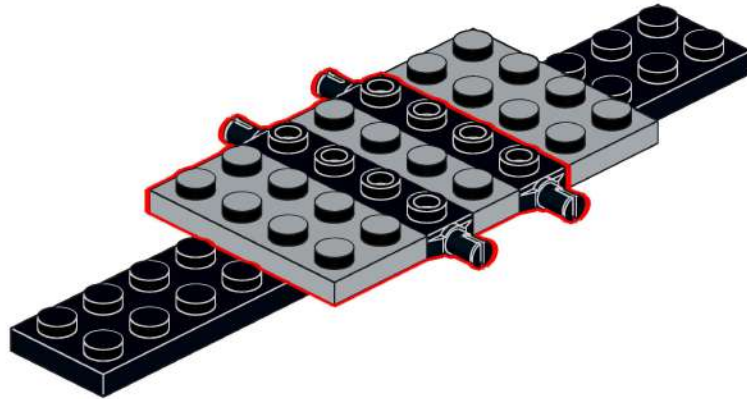
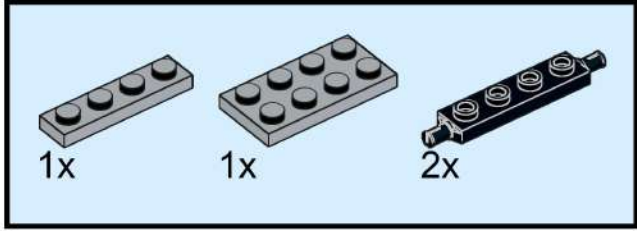

3

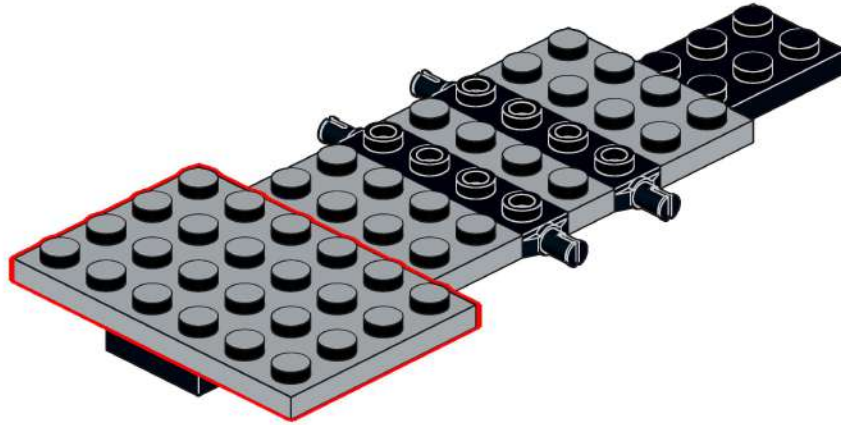
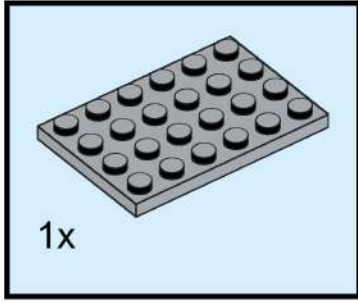

4

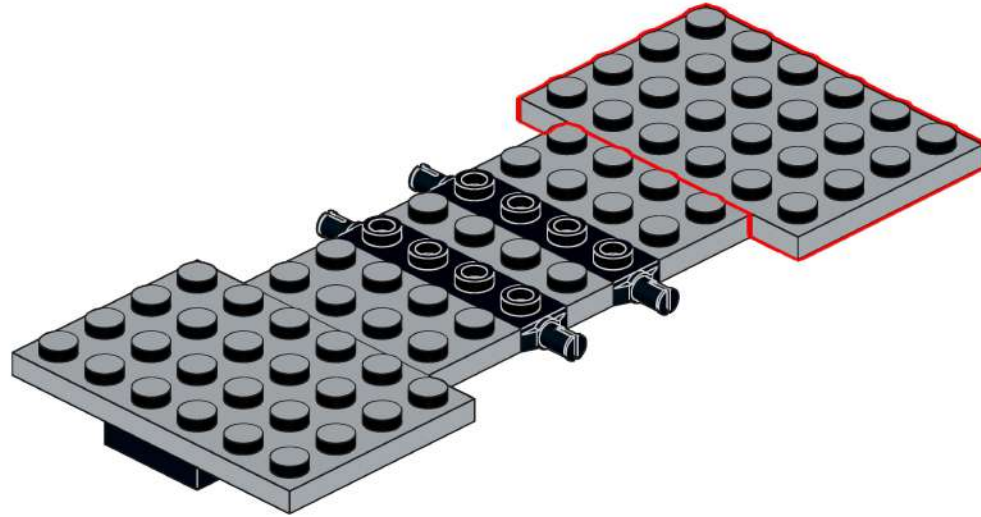
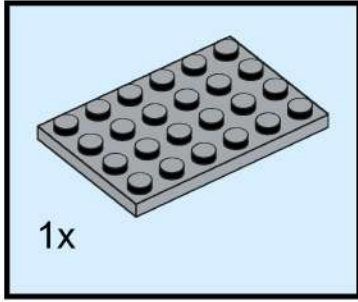

5

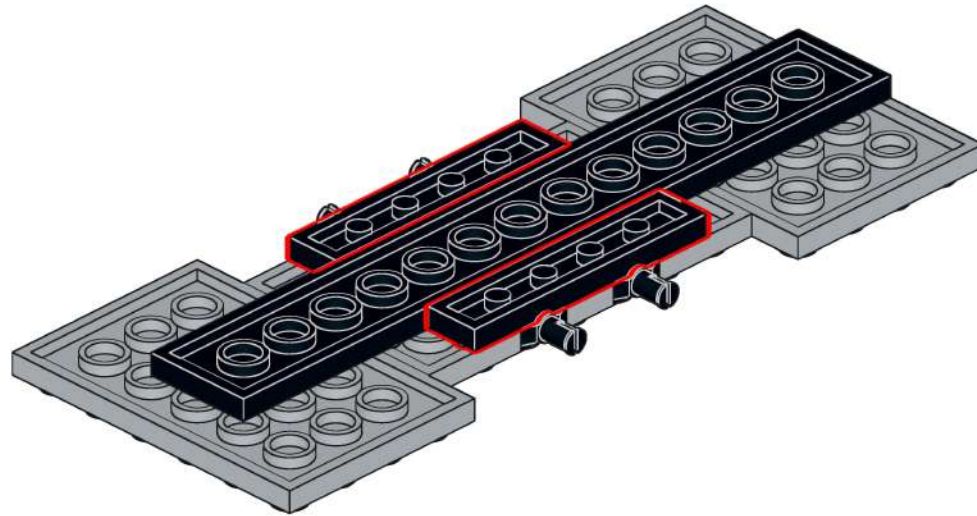
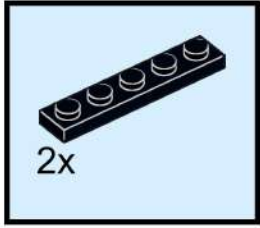

6

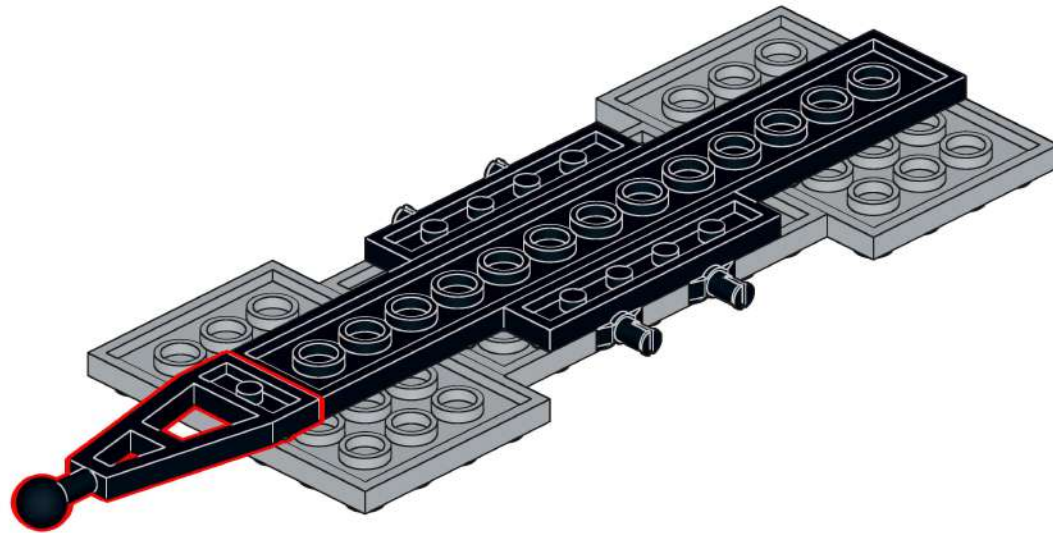
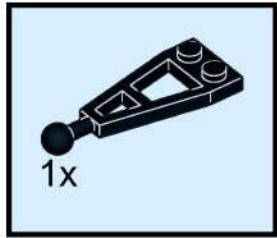

7

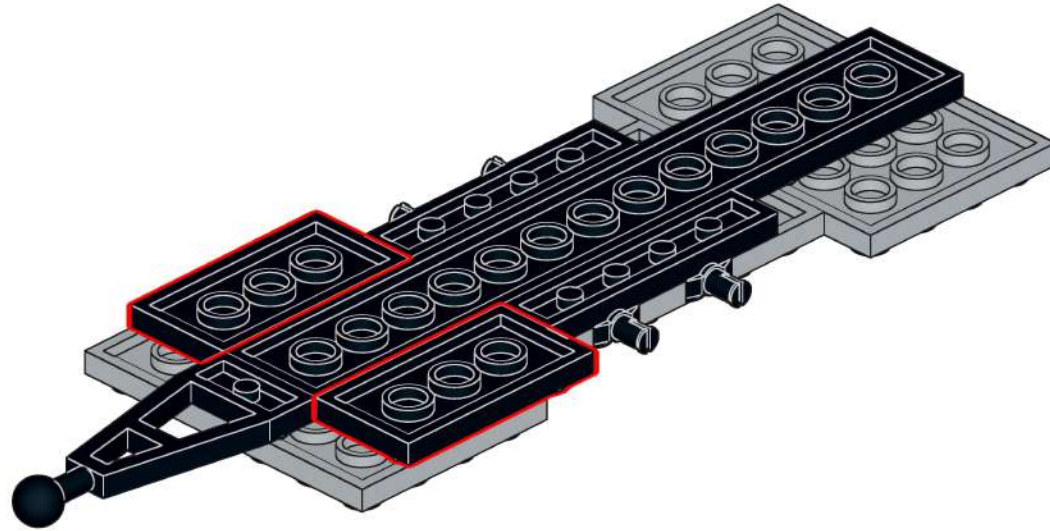
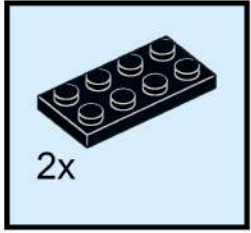

8

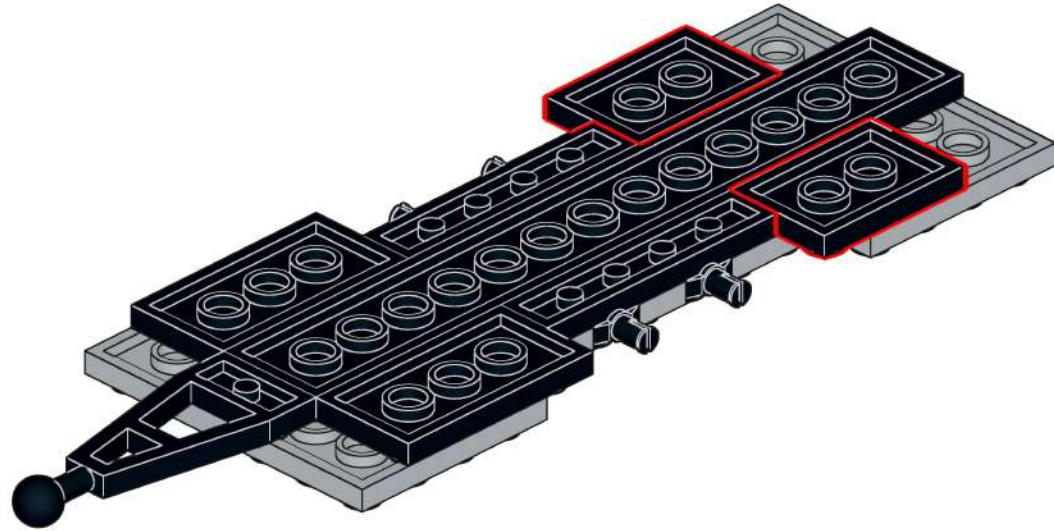

9

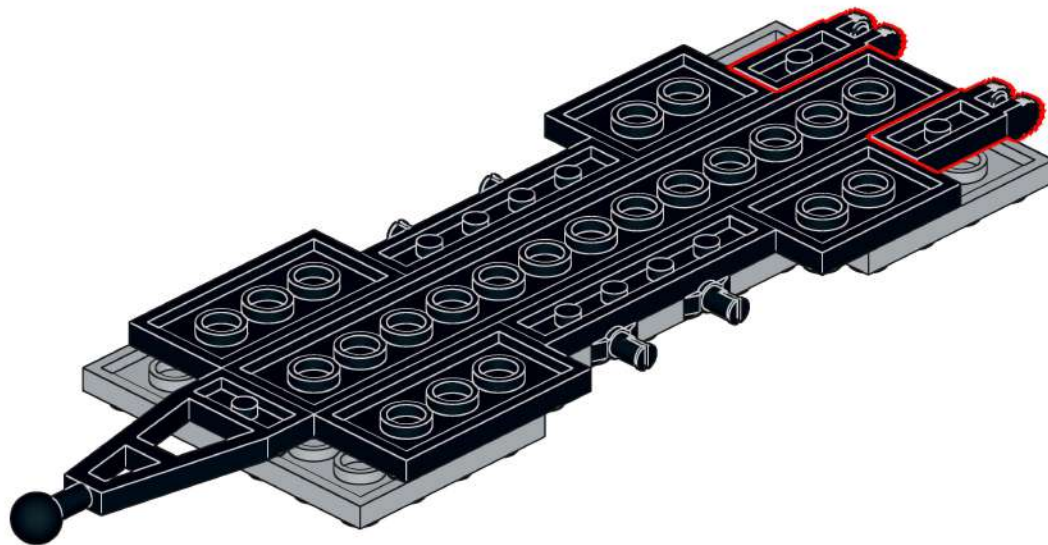

10

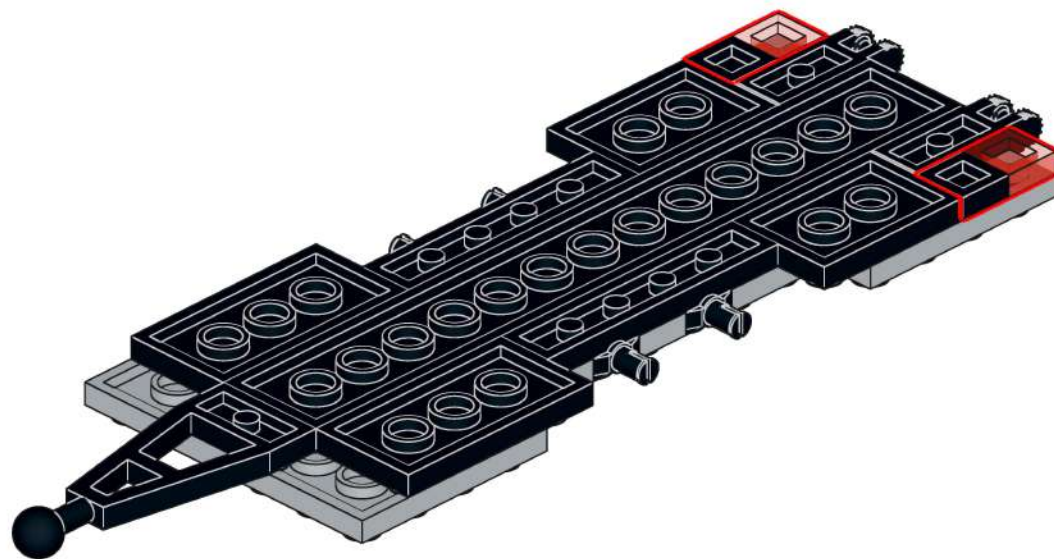
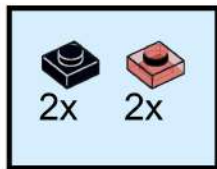

11

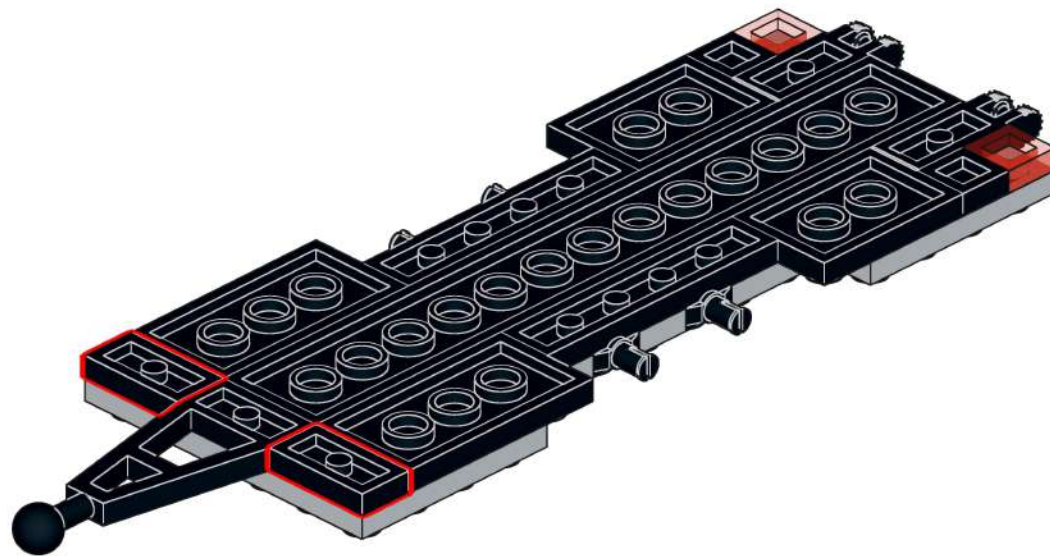
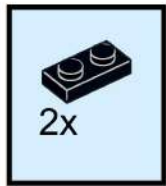

12

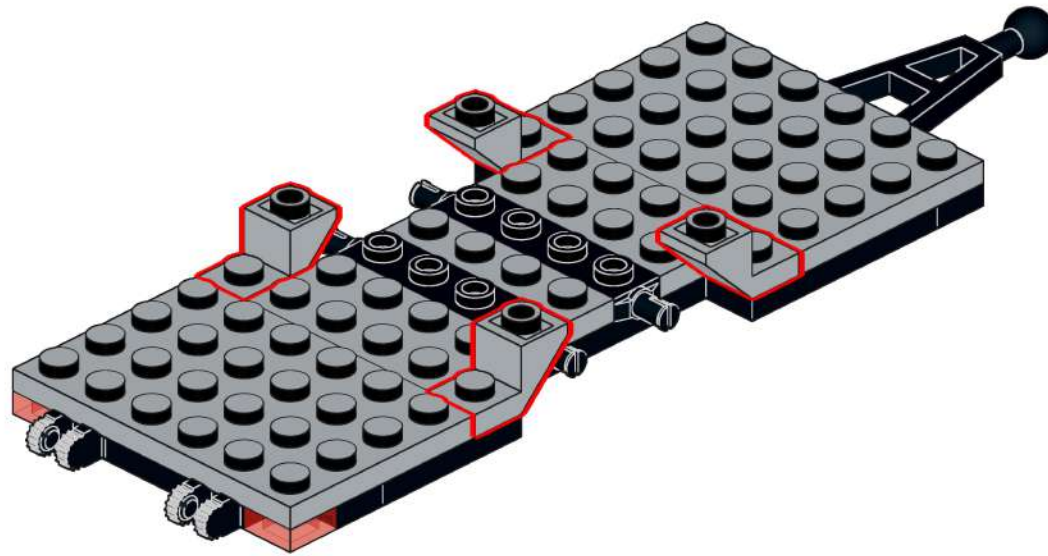
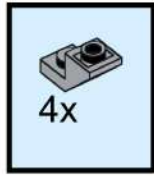

13

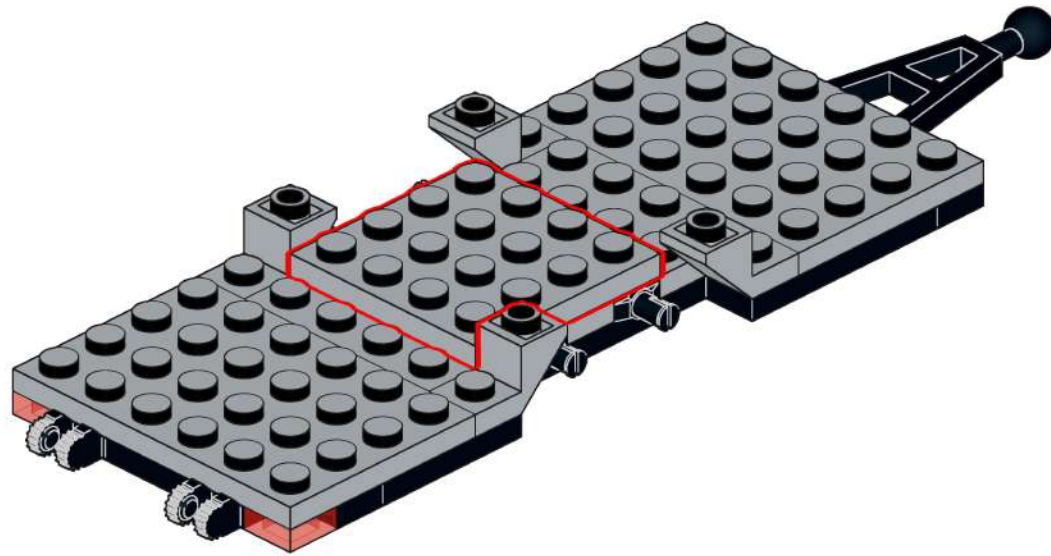
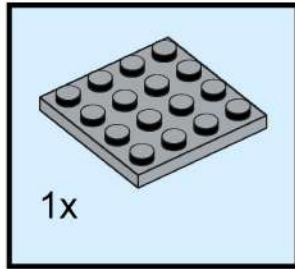

14

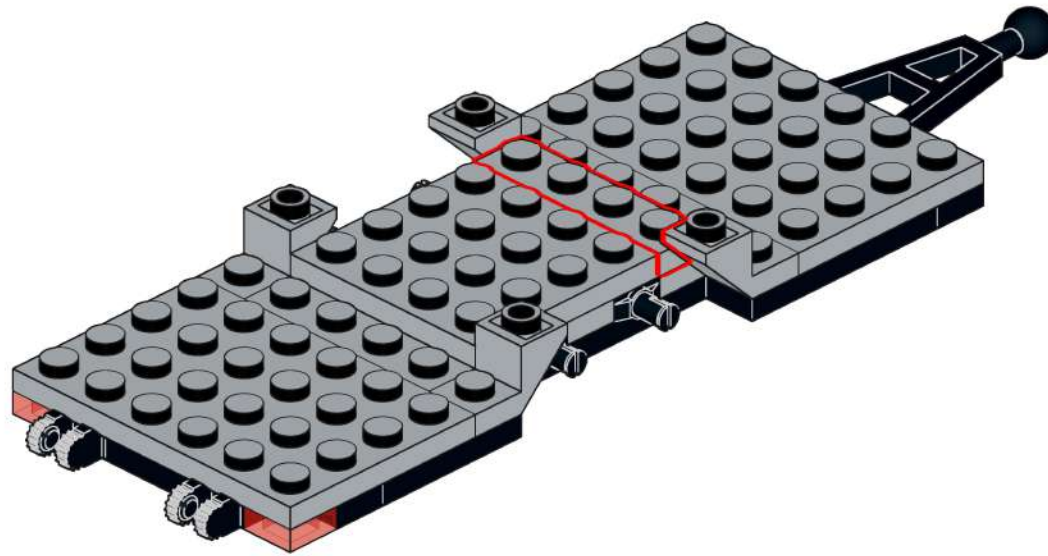
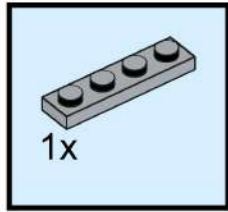

15

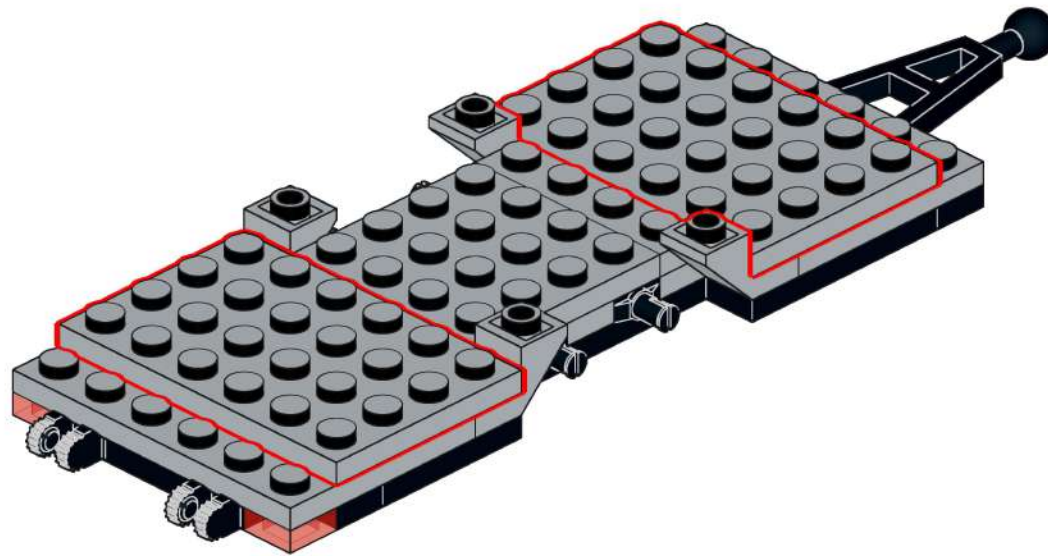
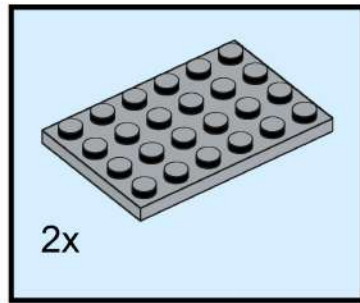

16

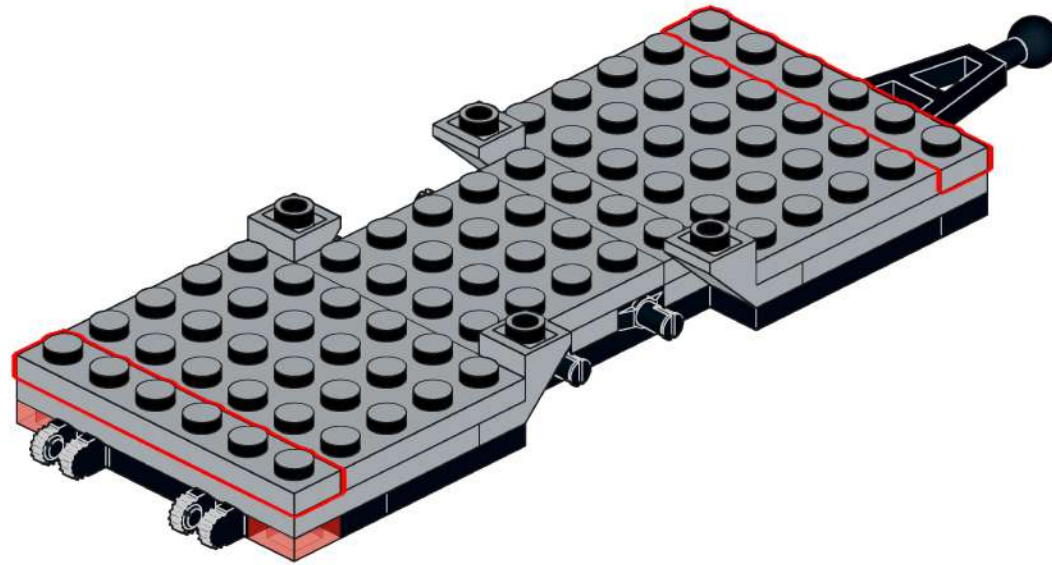
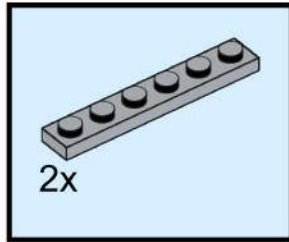

17

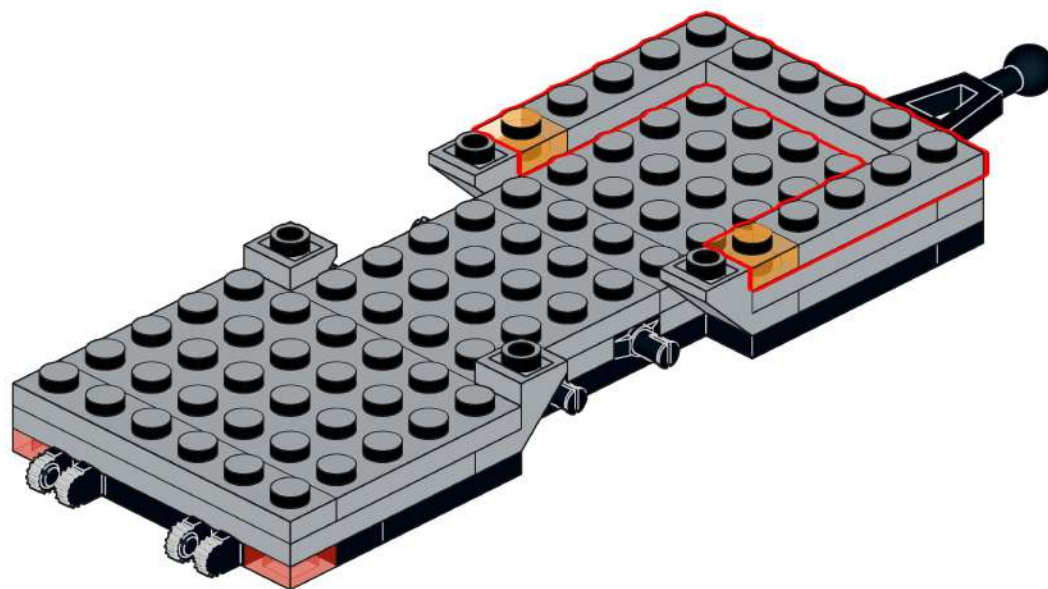
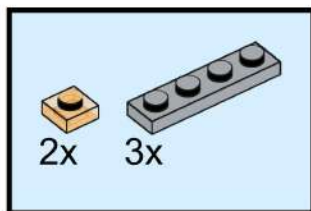

18

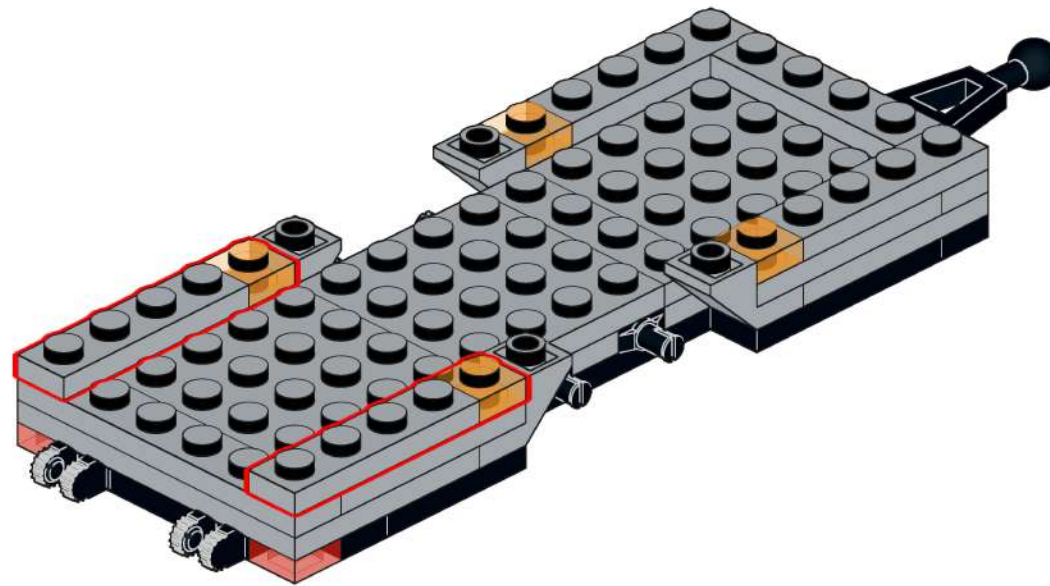
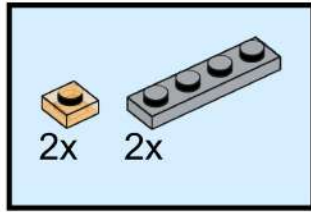

19

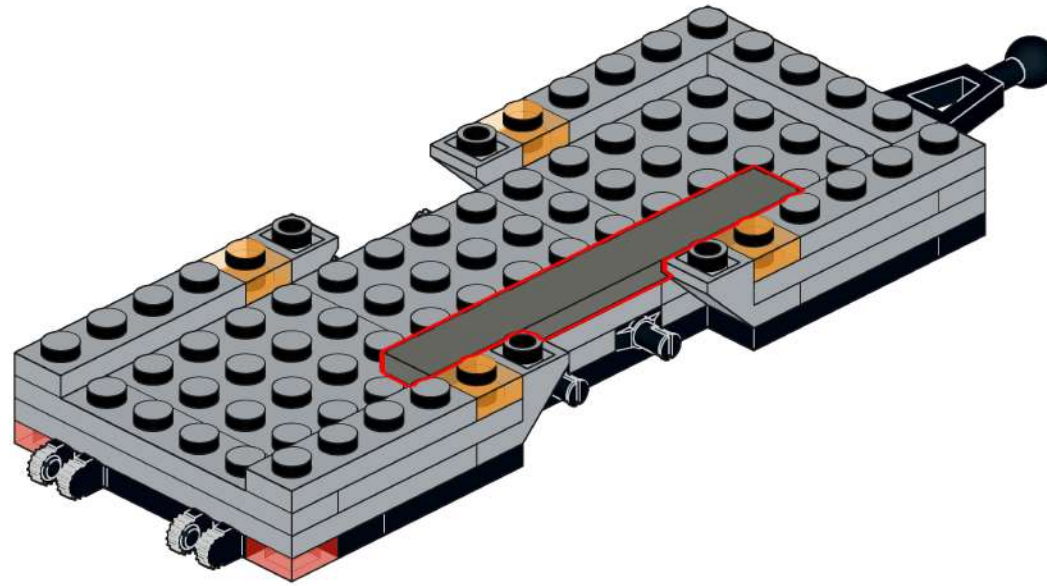
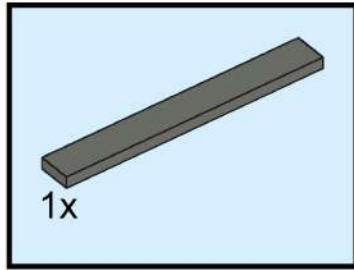

20

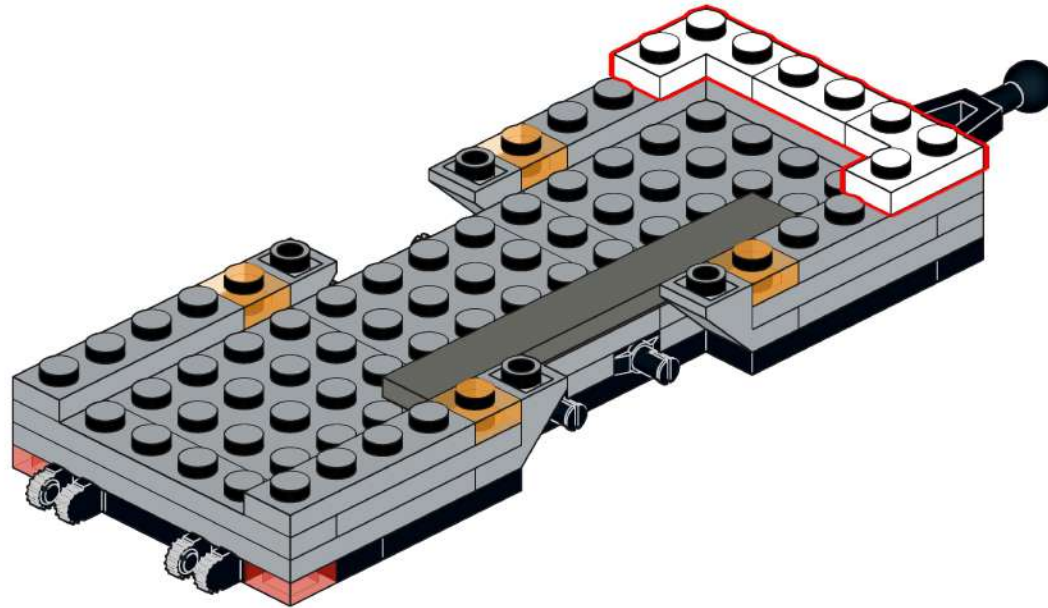
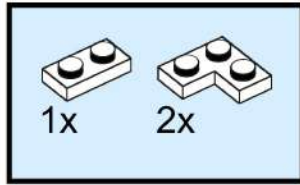

21

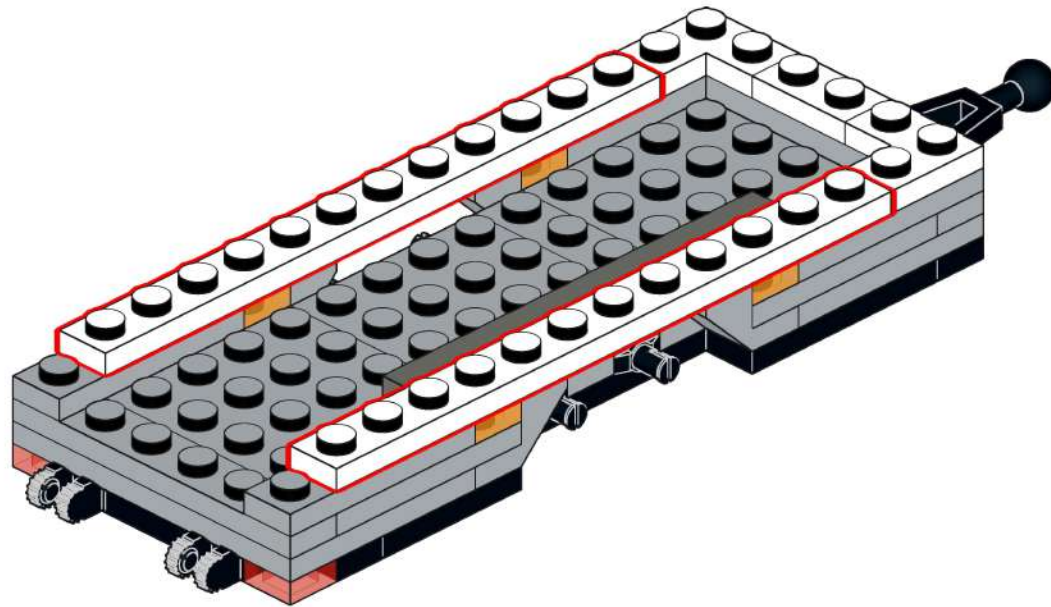
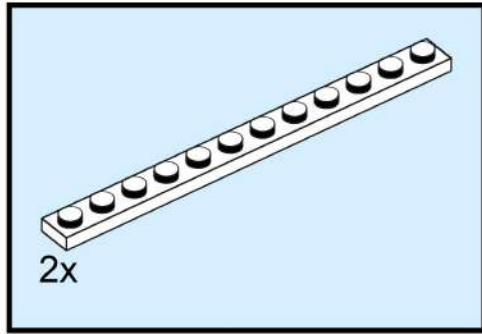

22

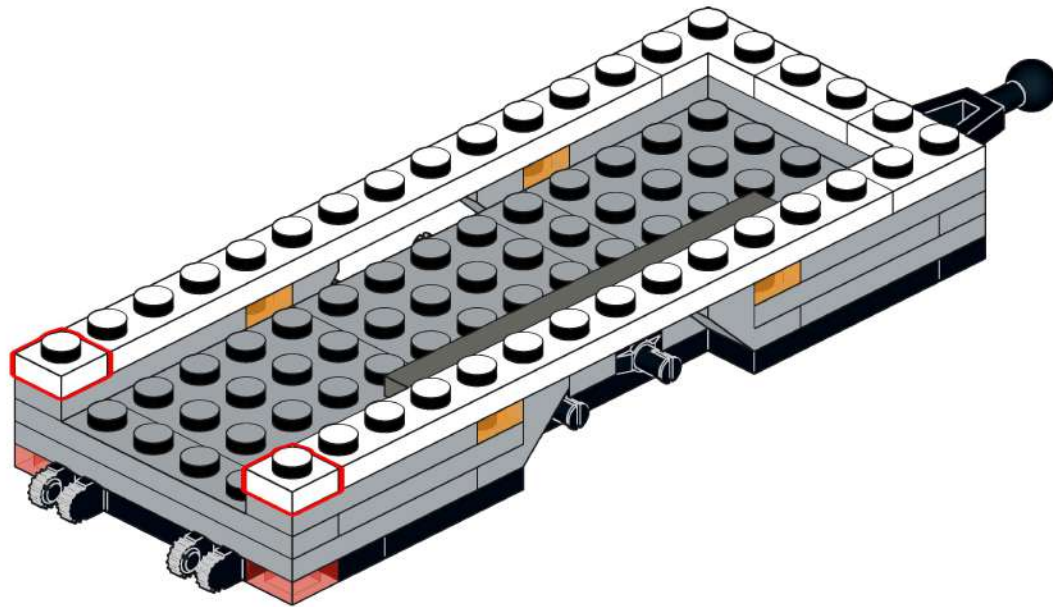
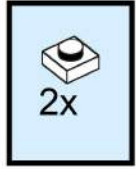

23

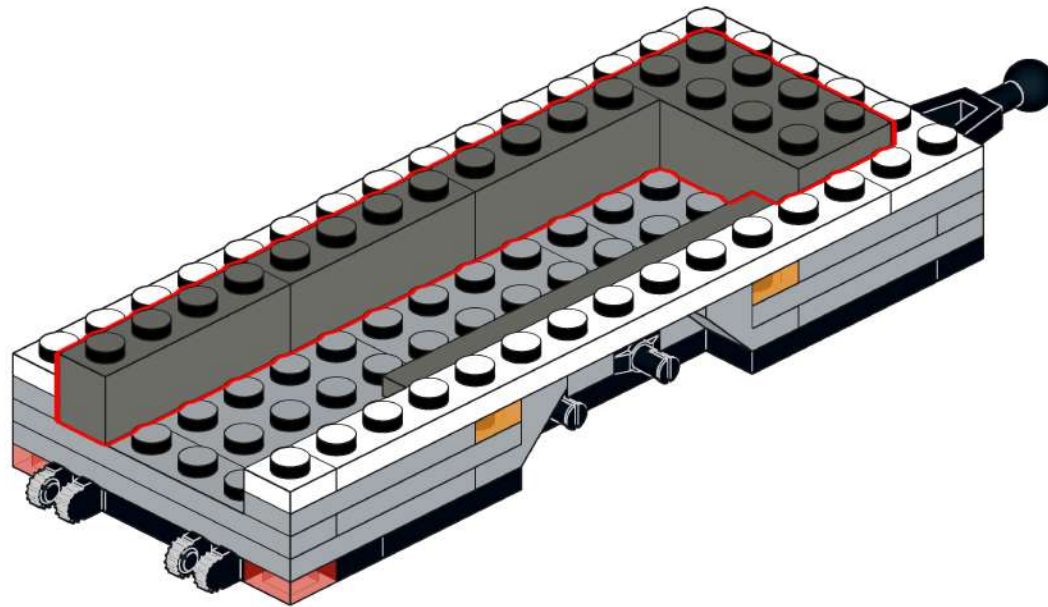
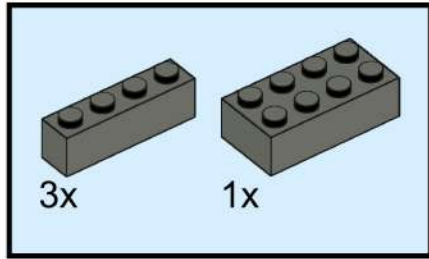

24

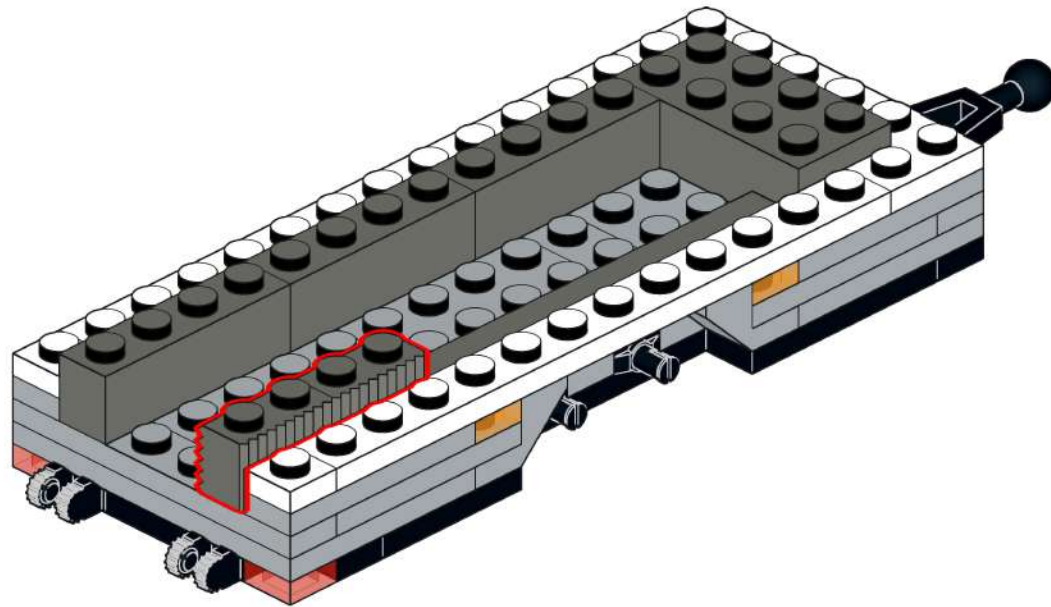
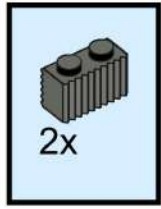

25

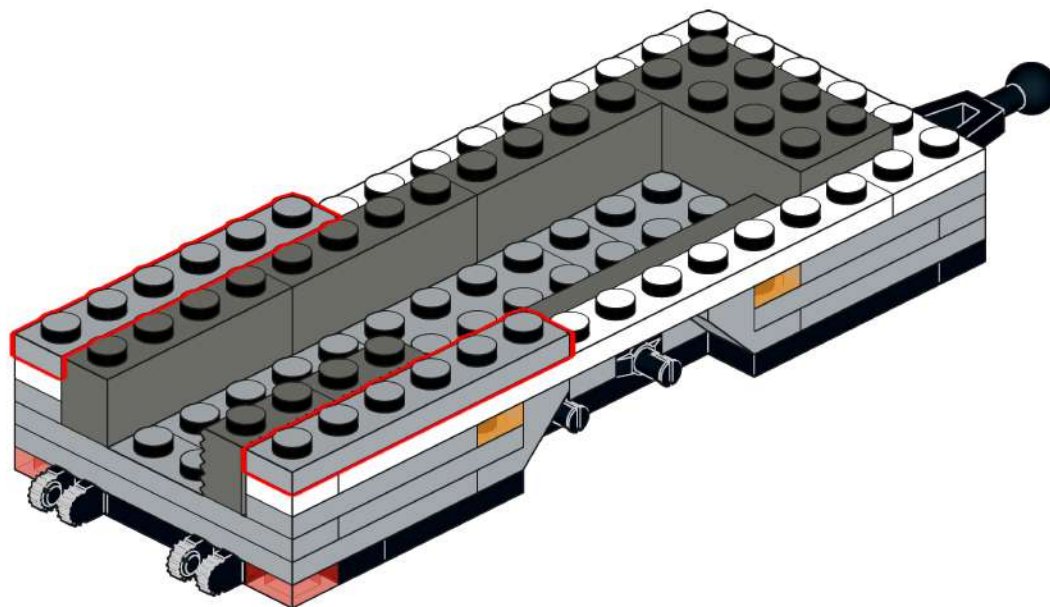
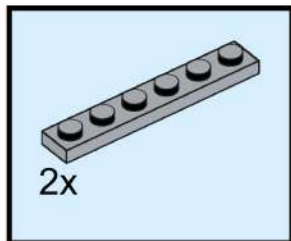

26

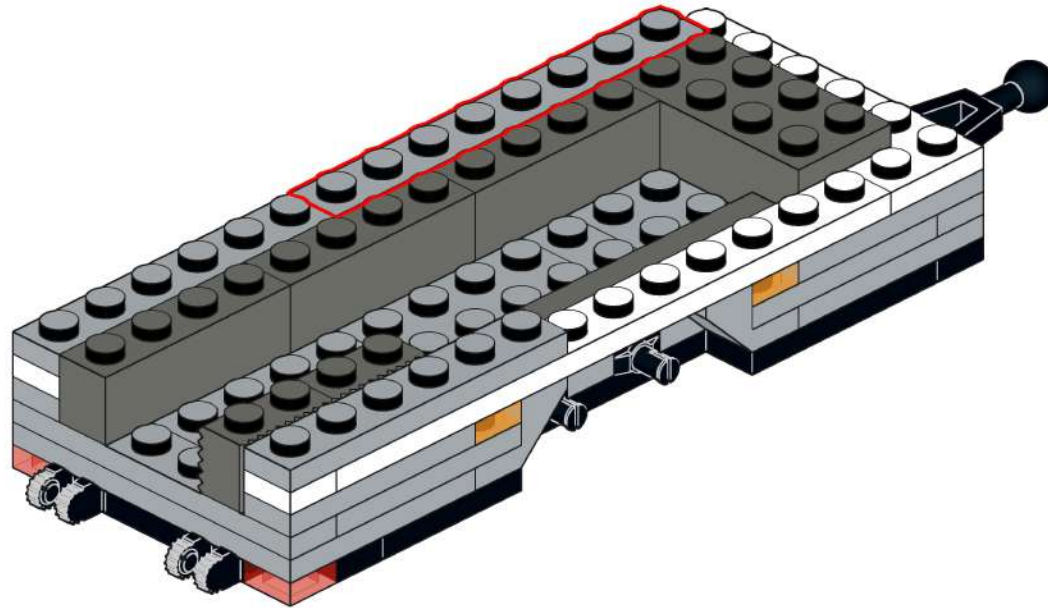
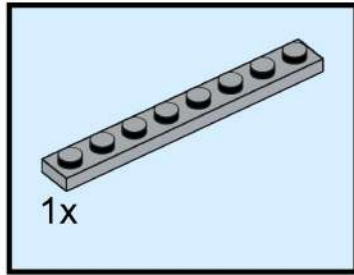

27

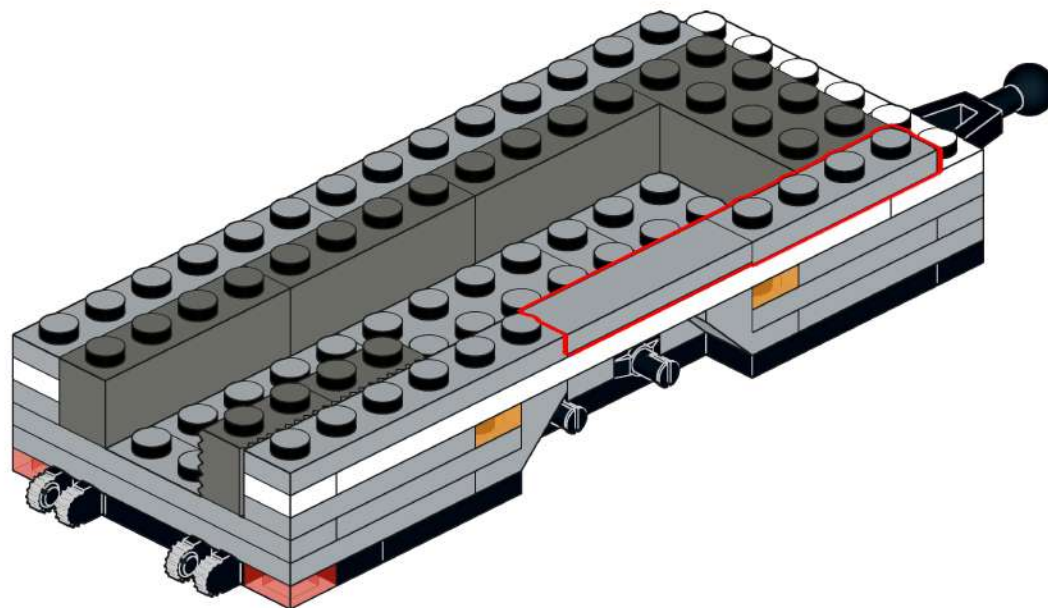
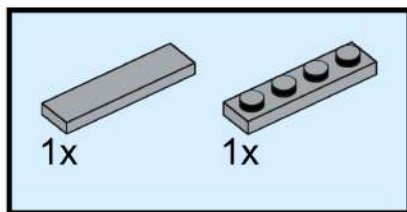

28

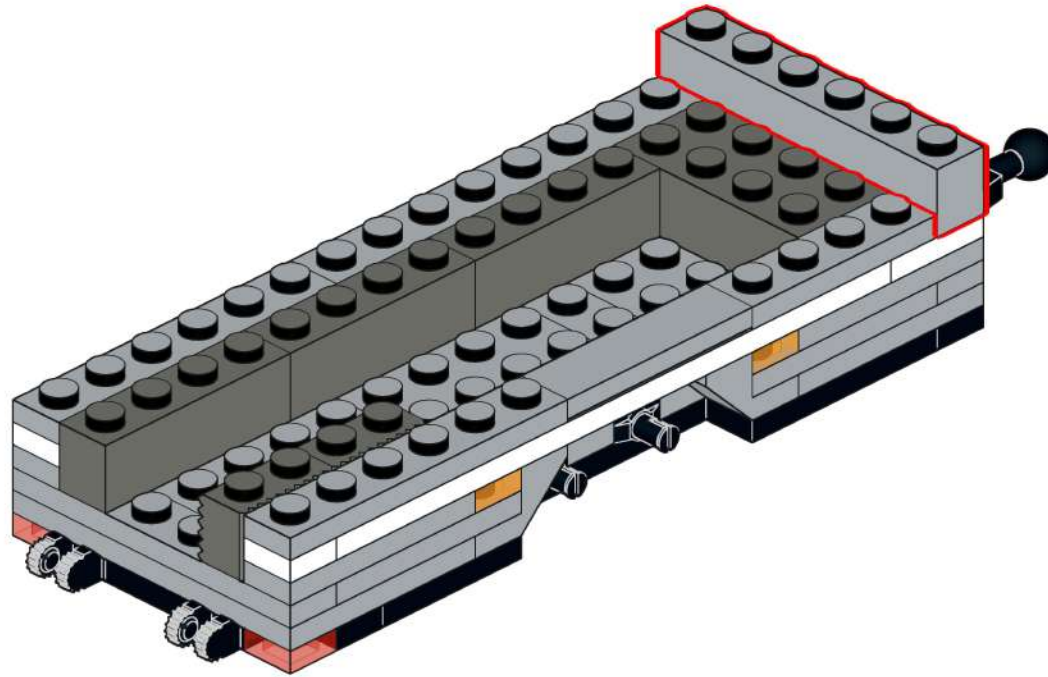
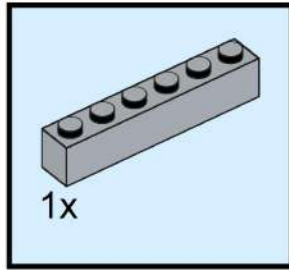

29

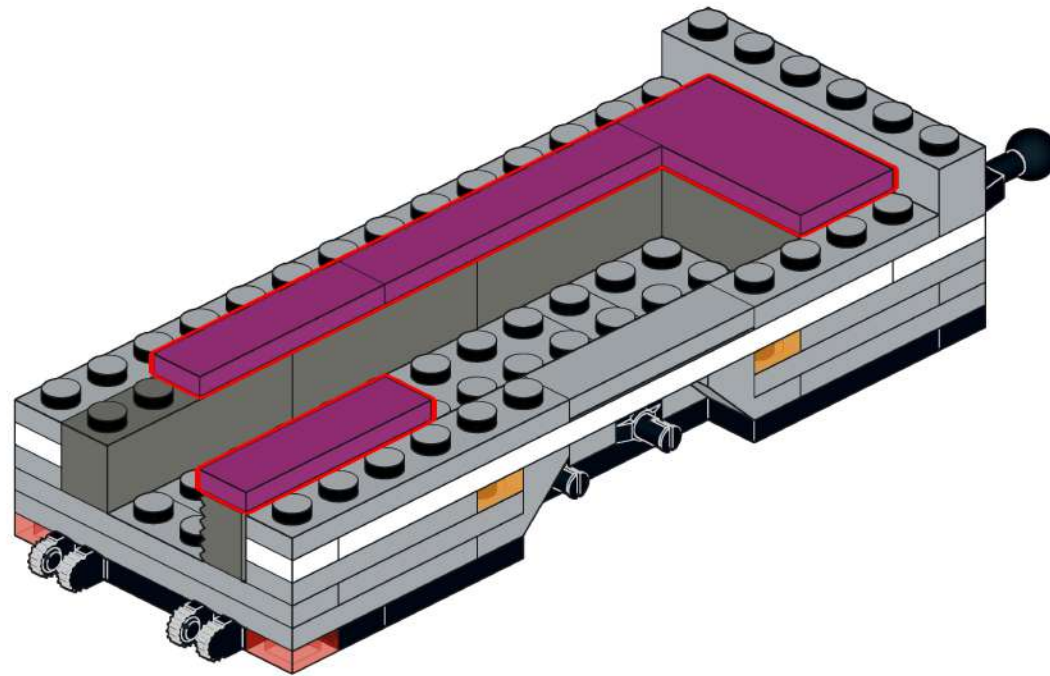
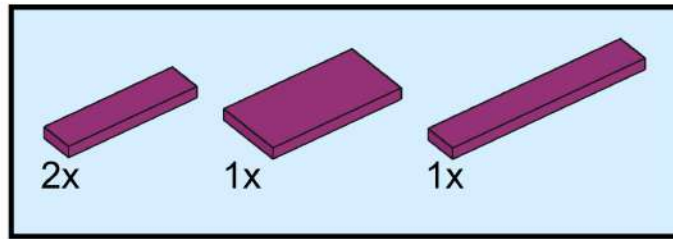

30

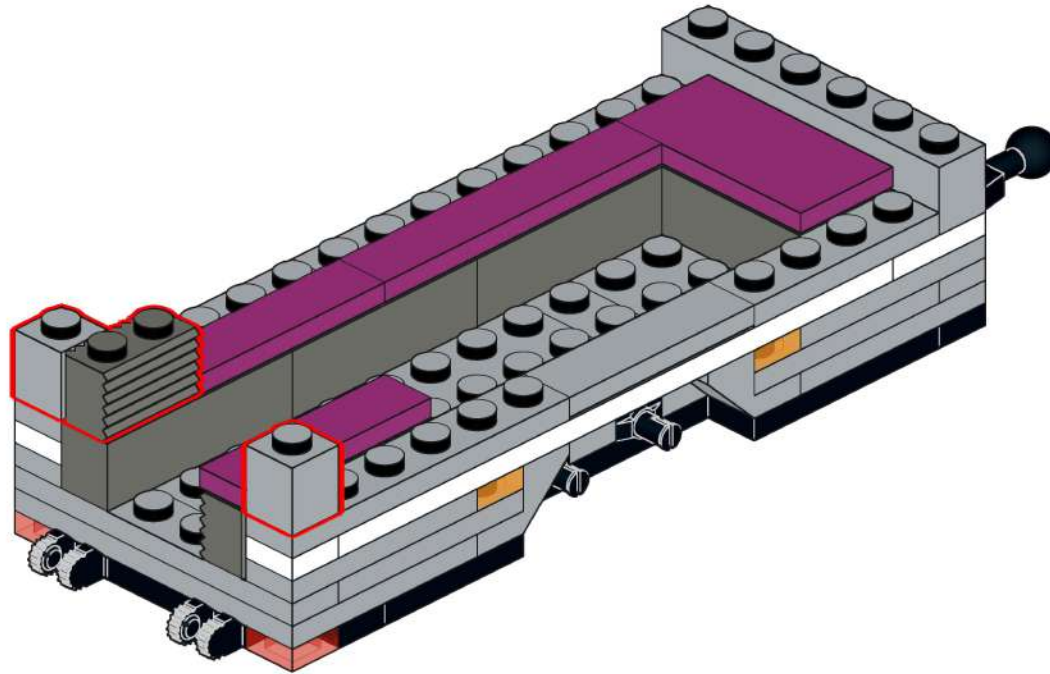
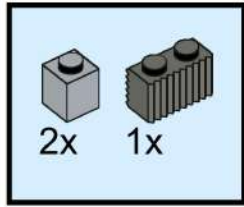

31

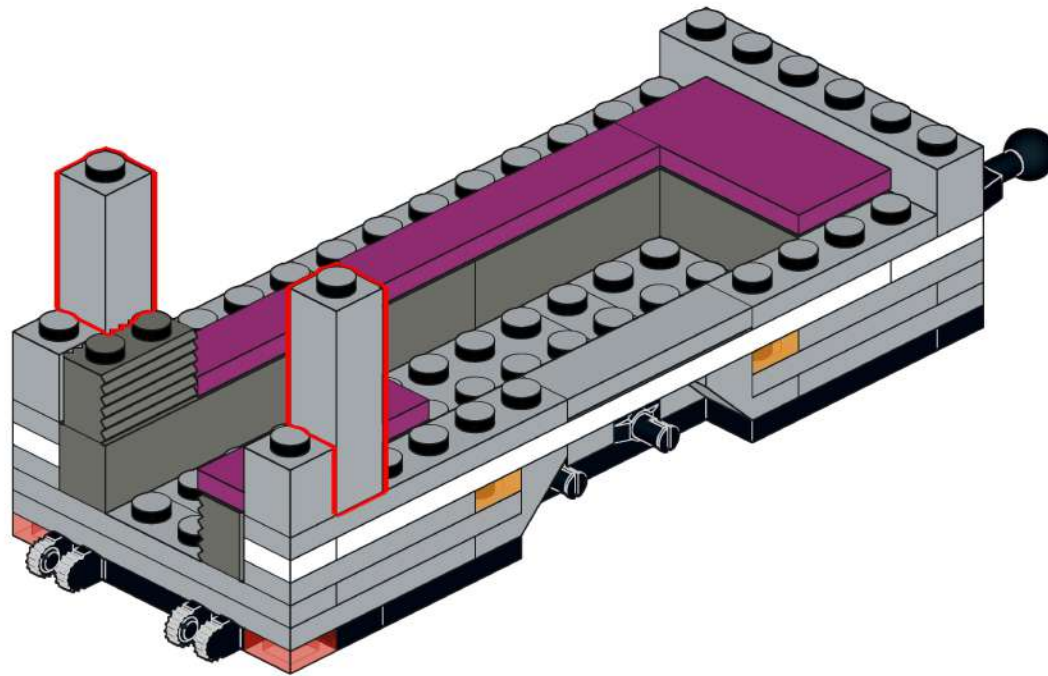
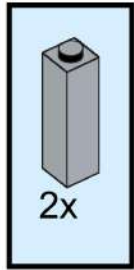

32

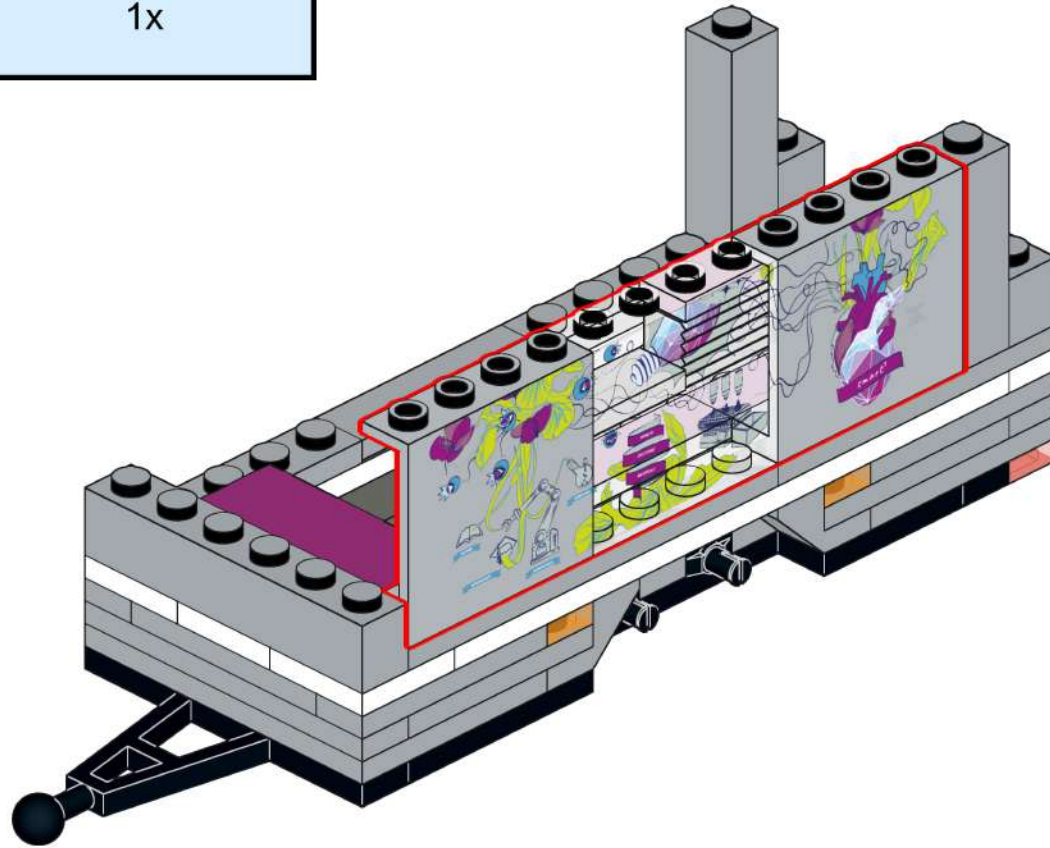
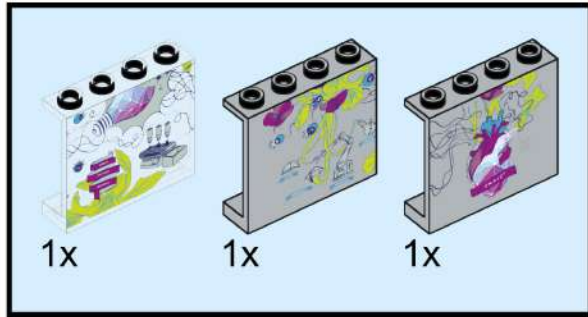

33

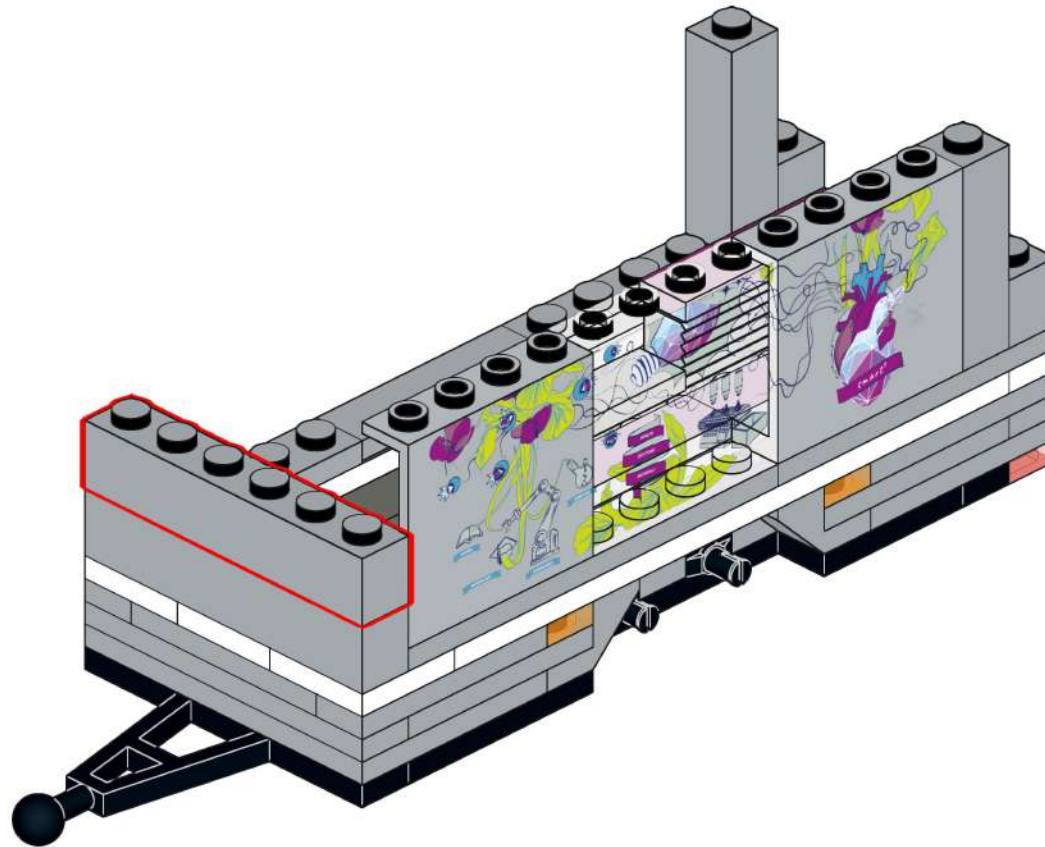
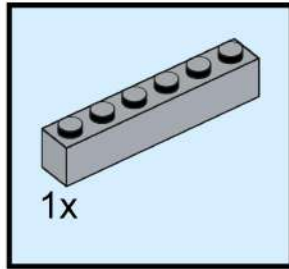

34

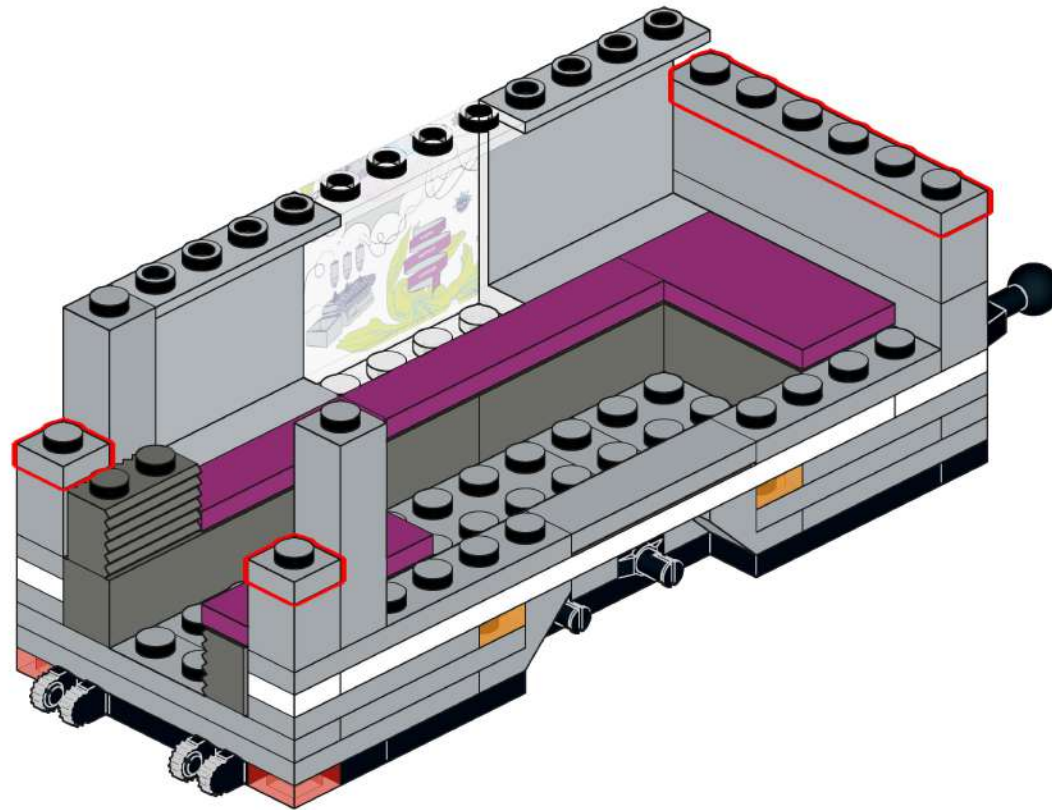
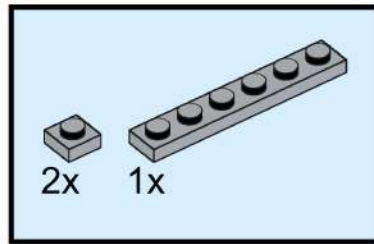

35

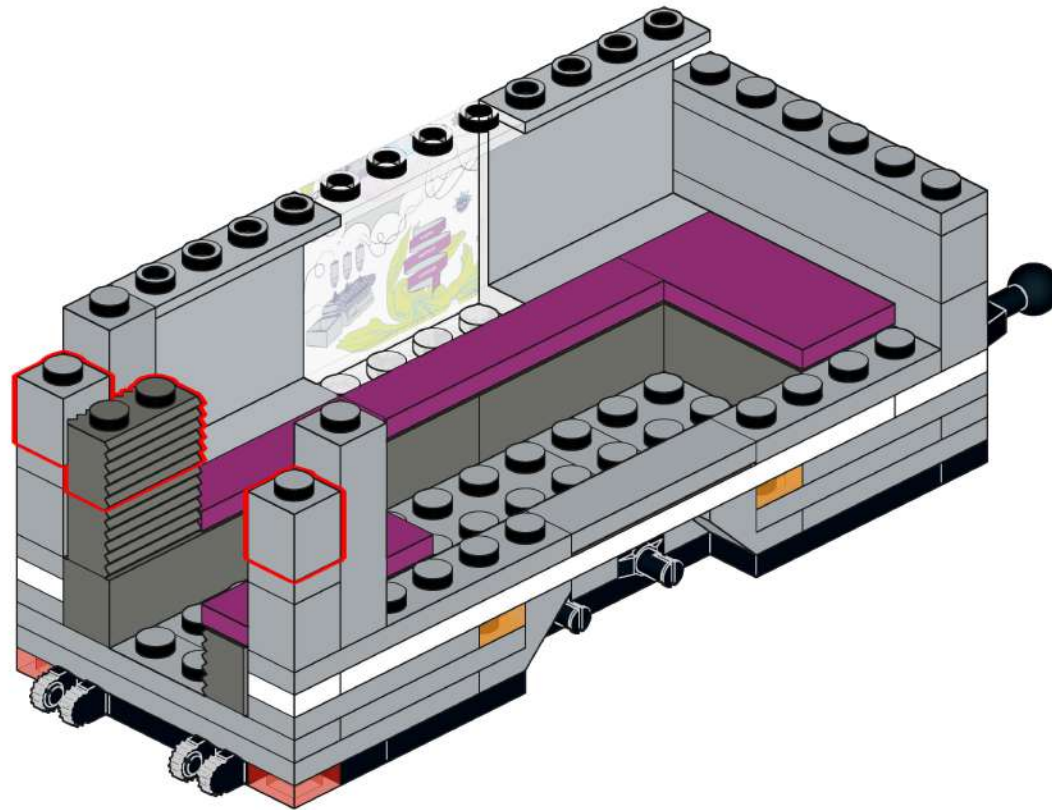
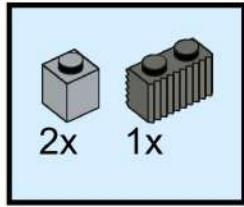

36

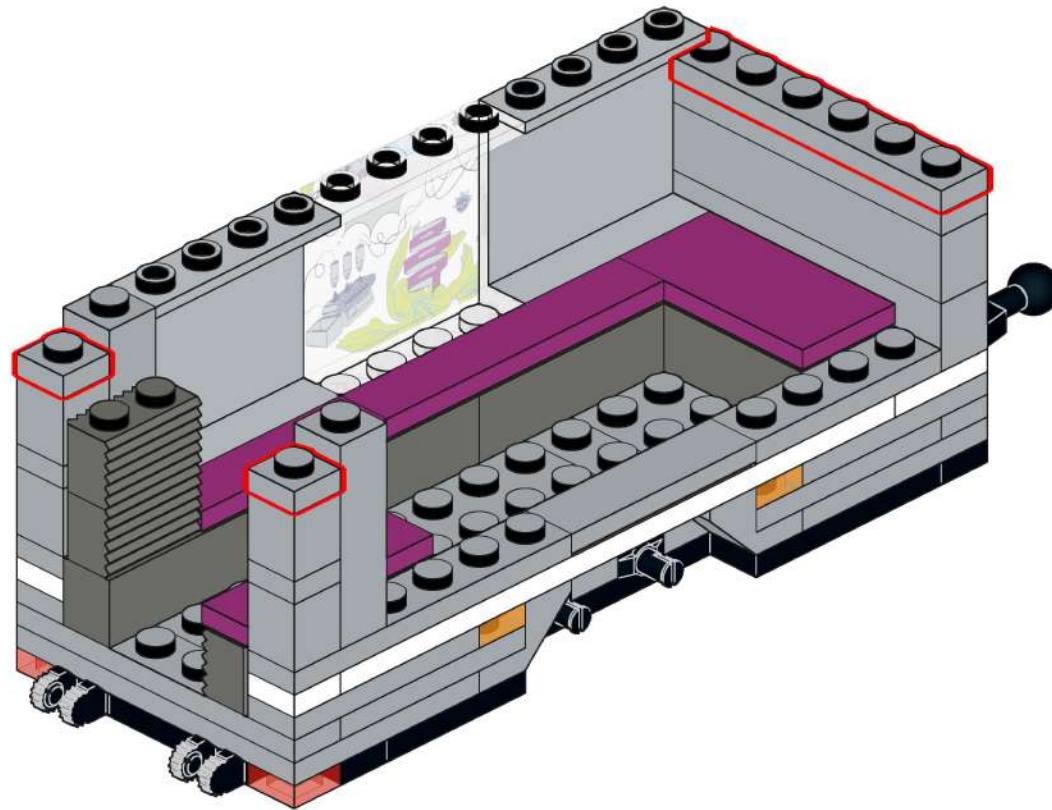
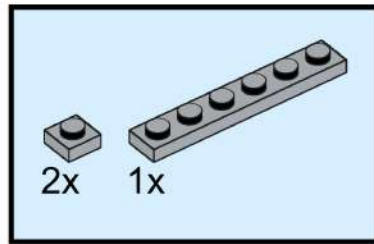

37

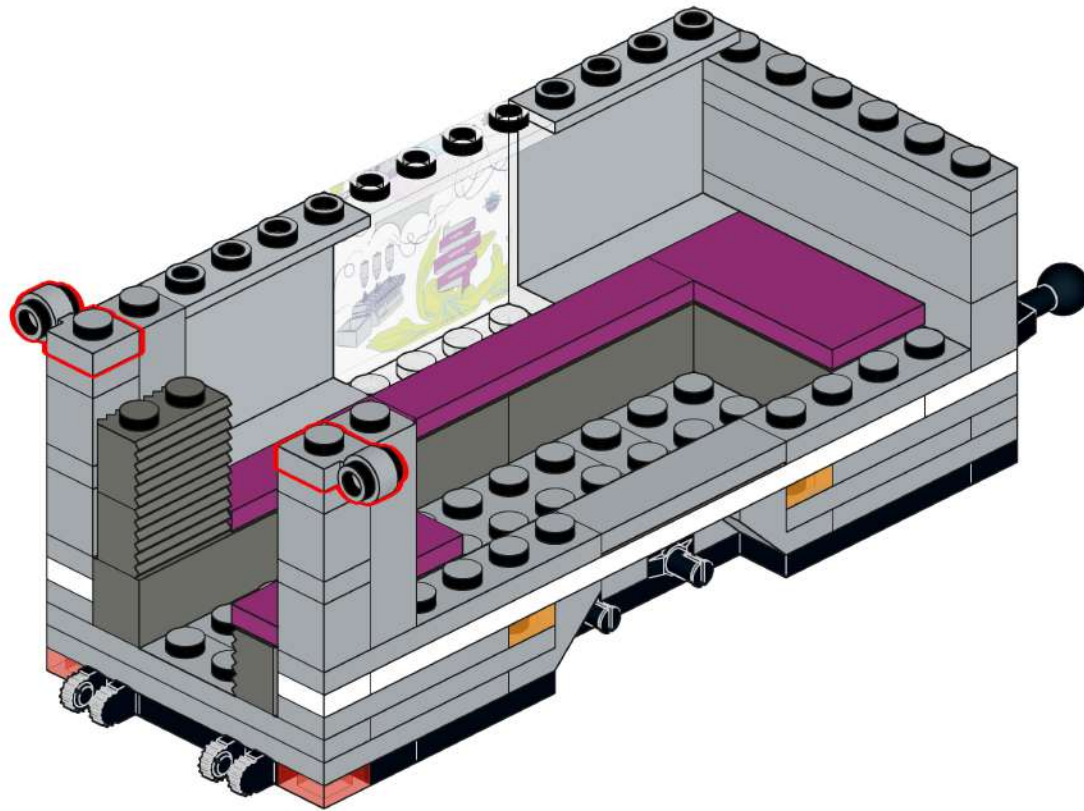
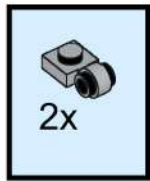

38

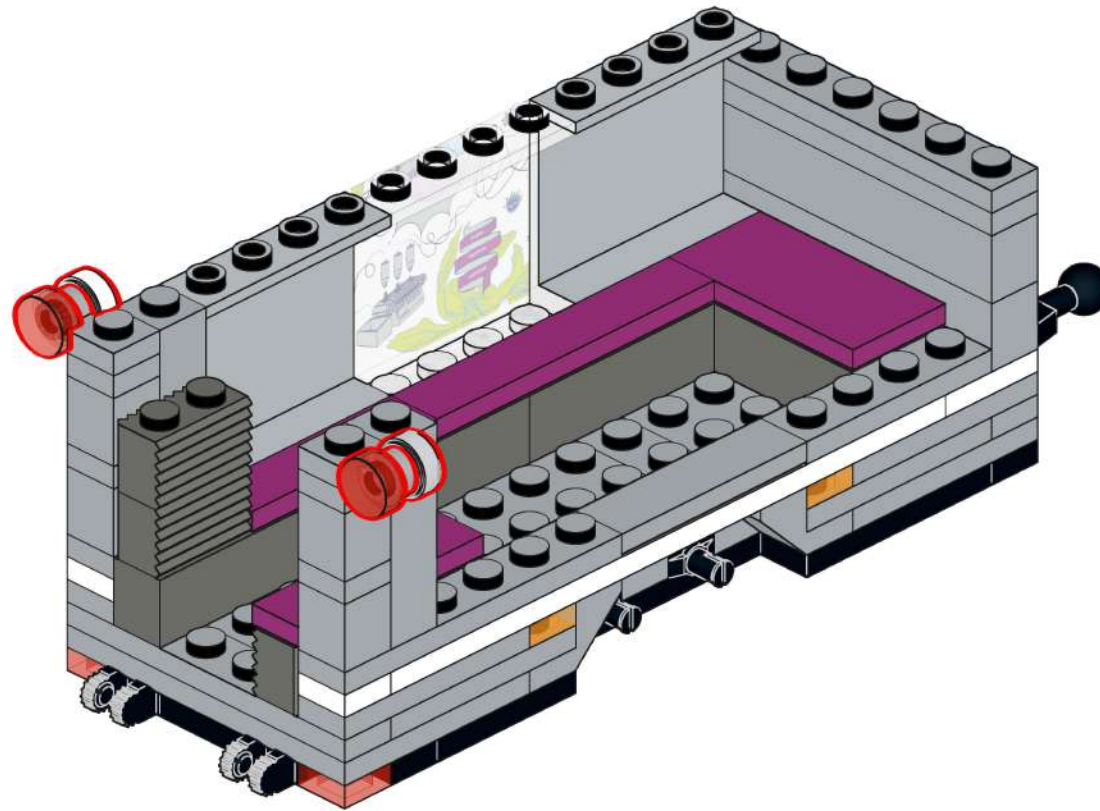
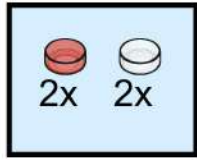

39

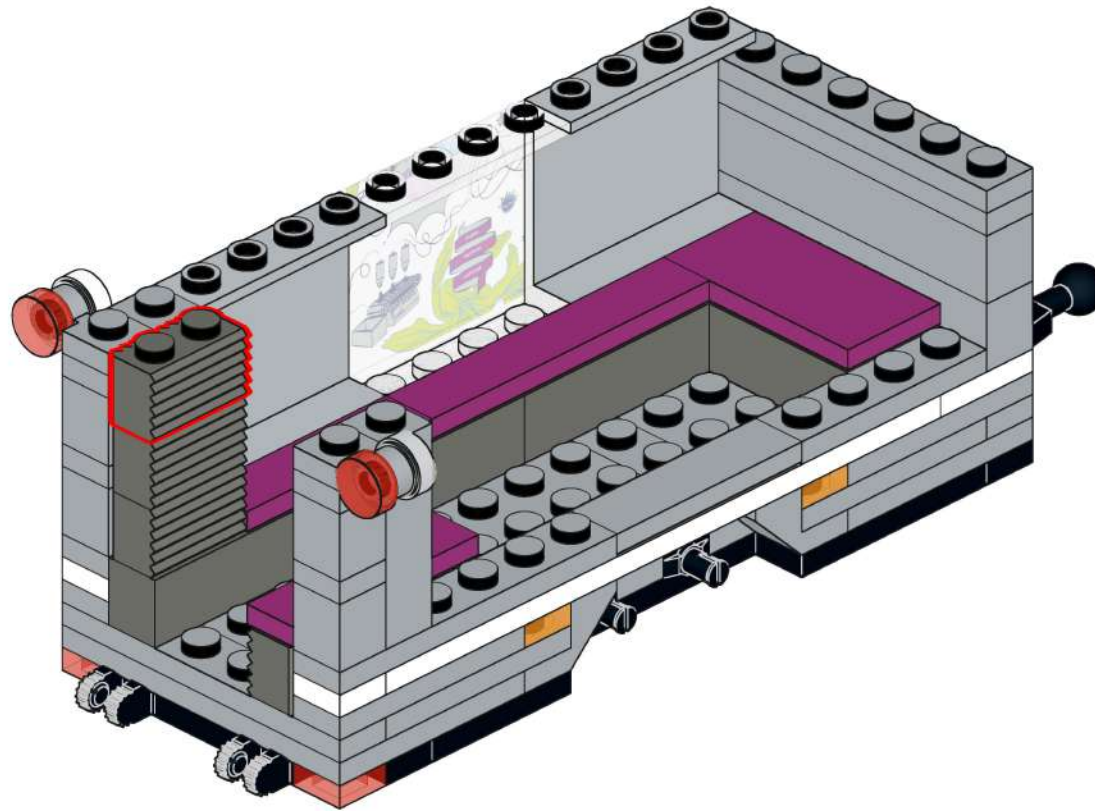
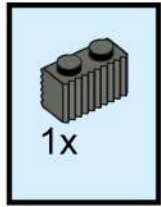

40

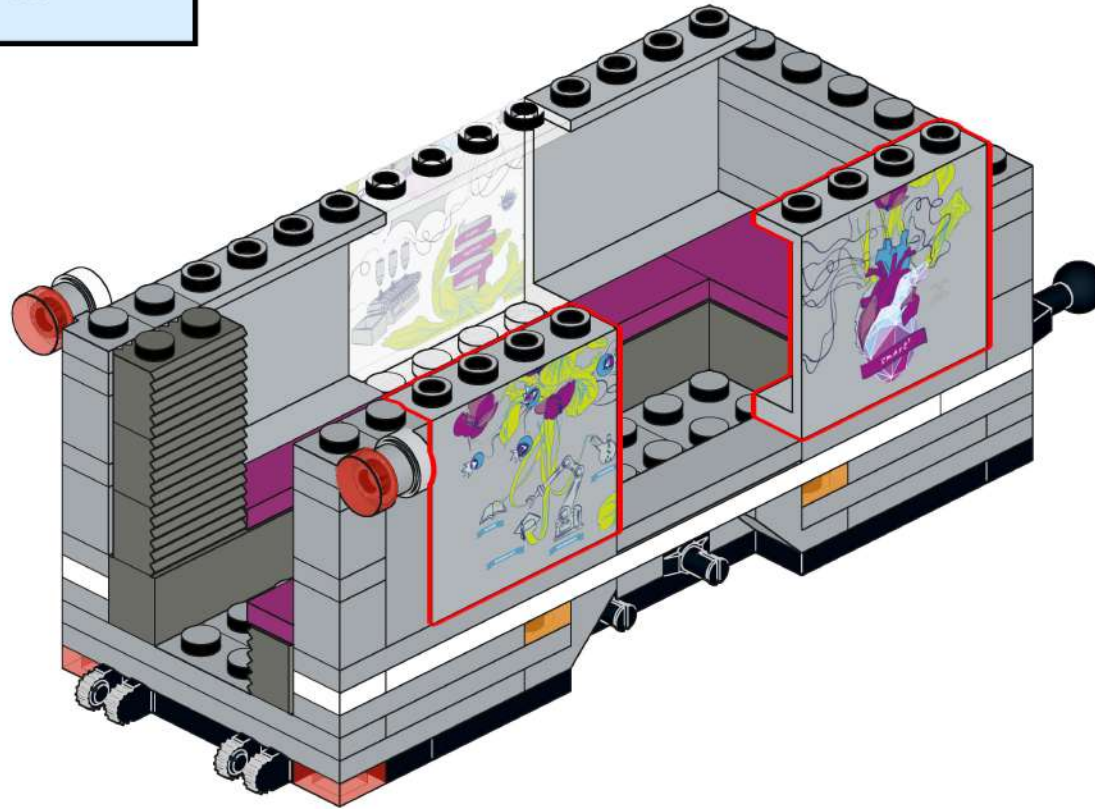
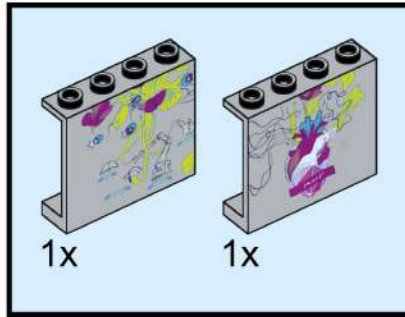

41

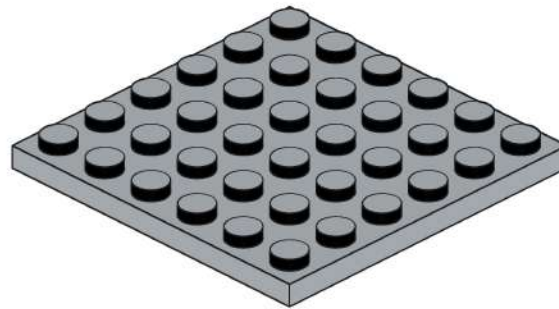
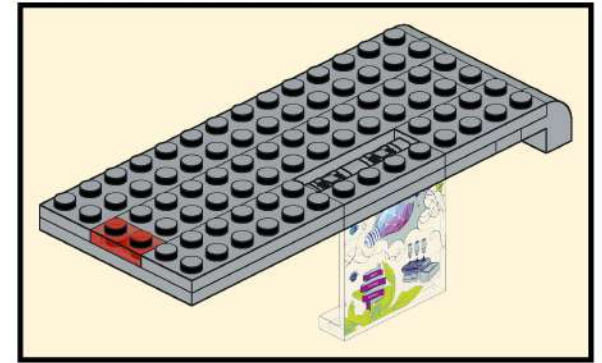
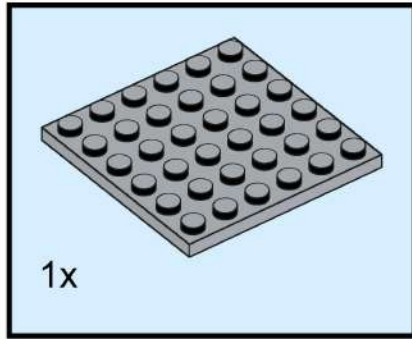

42

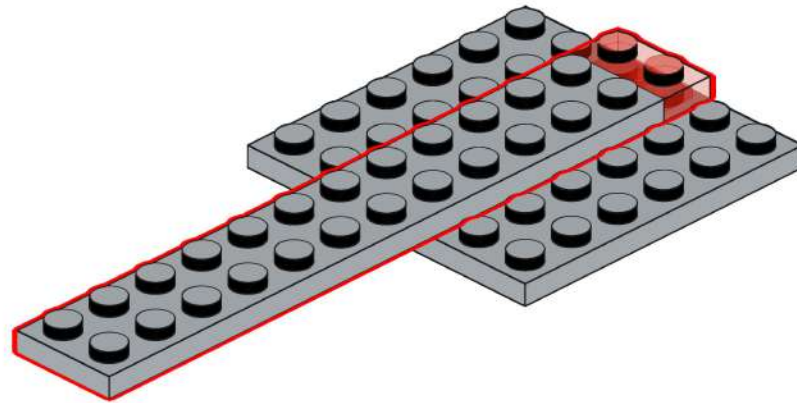
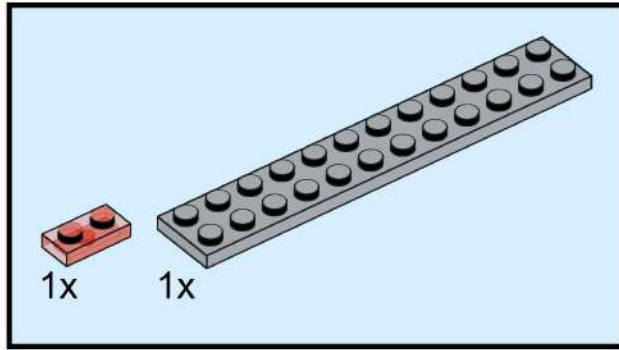

43

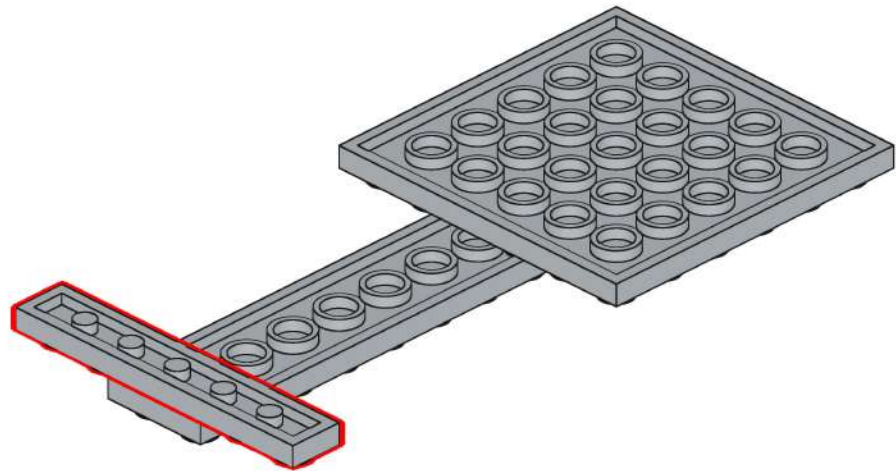
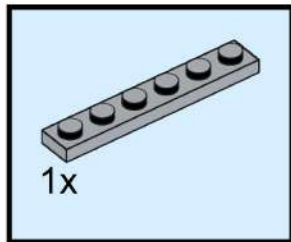

44

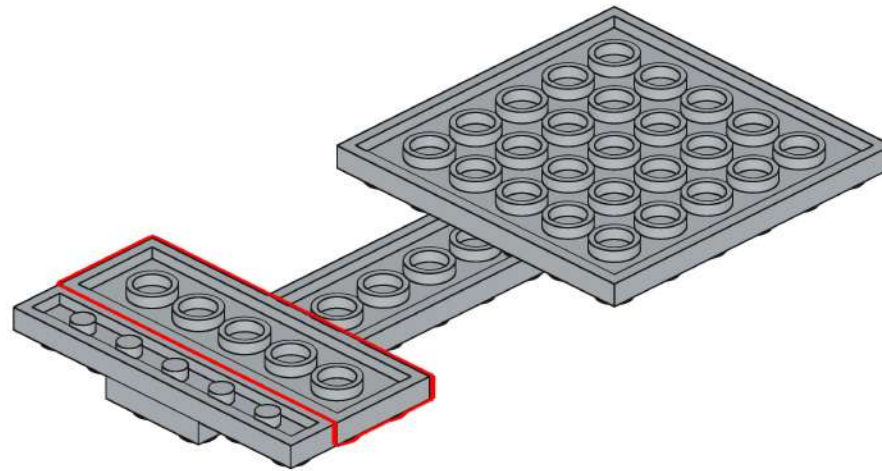
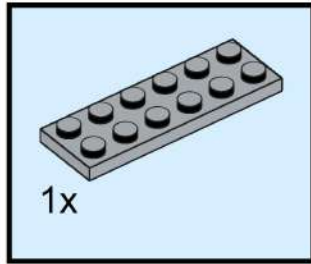

45

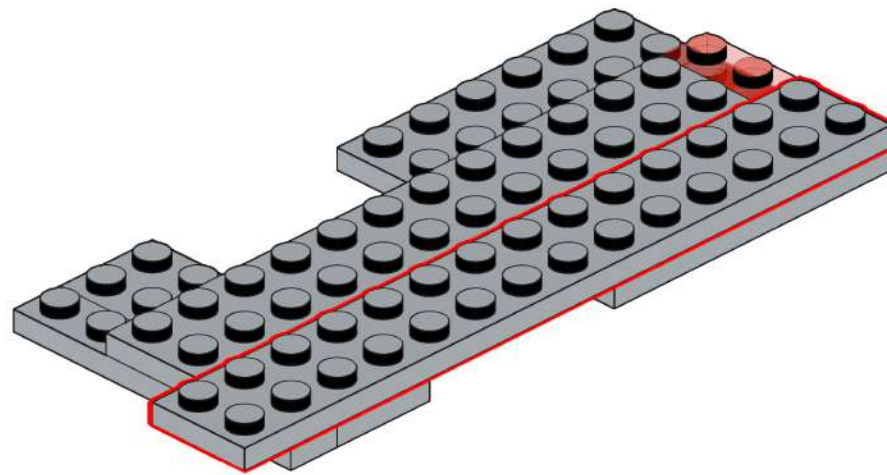
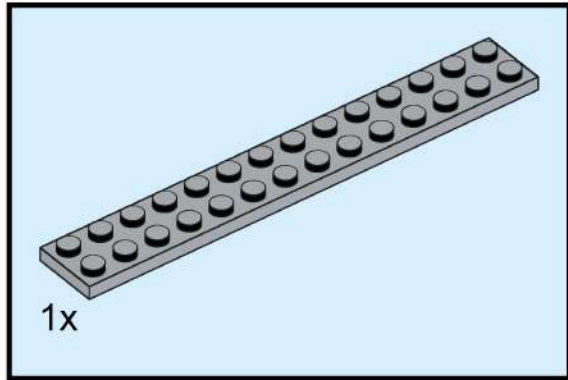

46

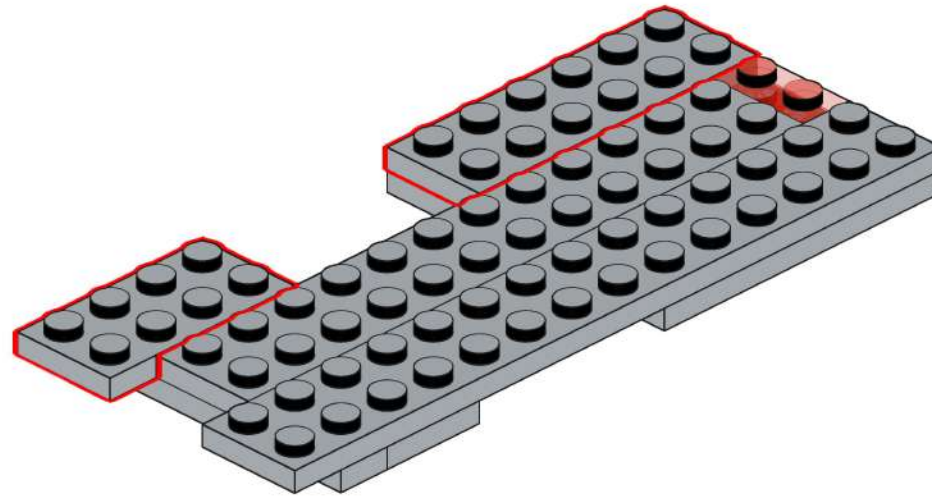
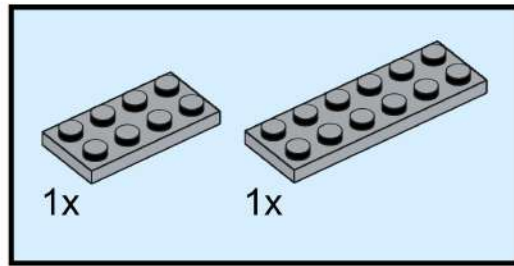

47

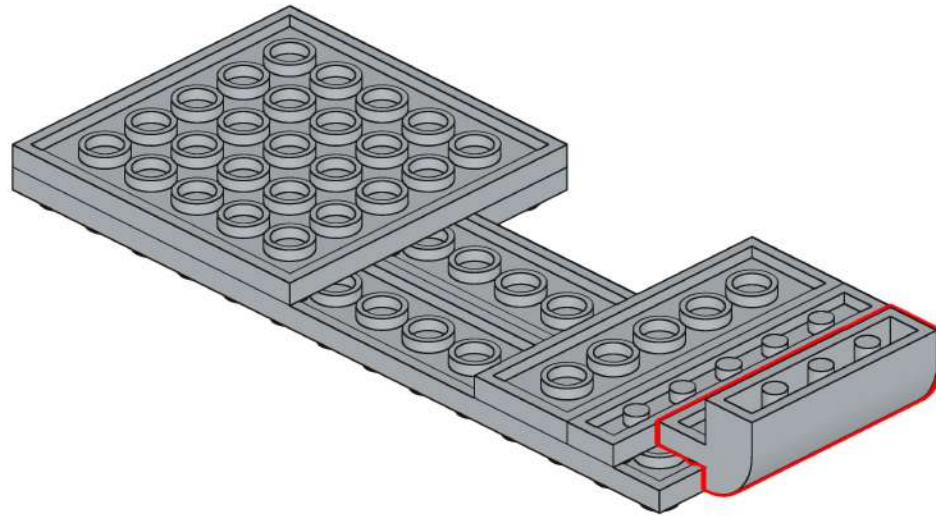
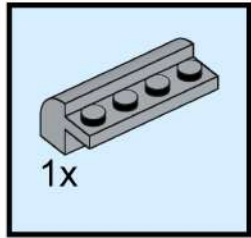

48

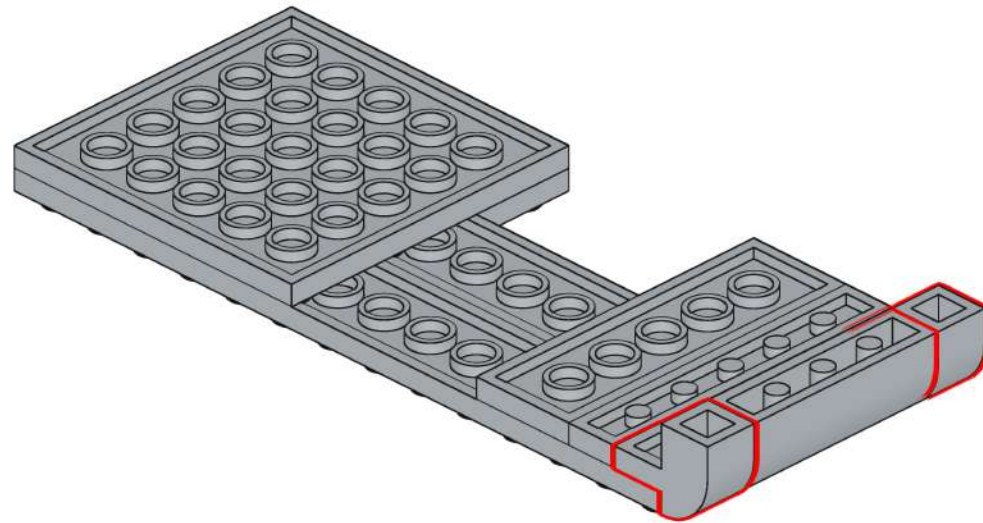
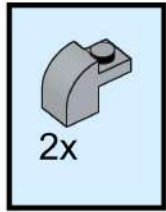

49

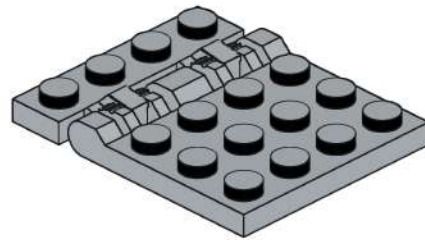
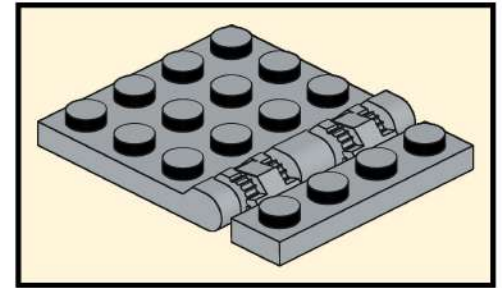
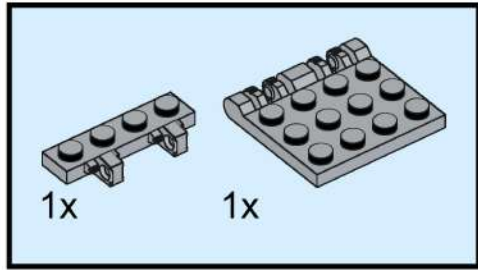

50

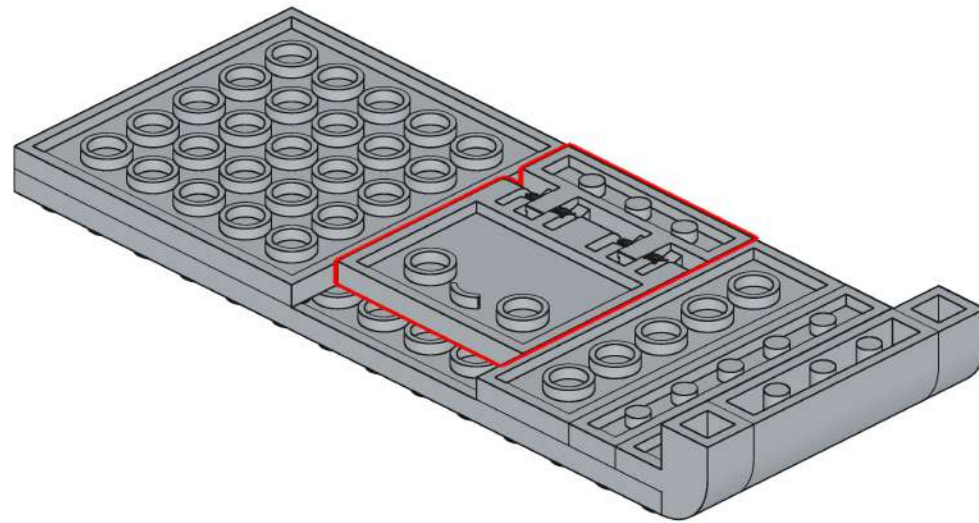

51

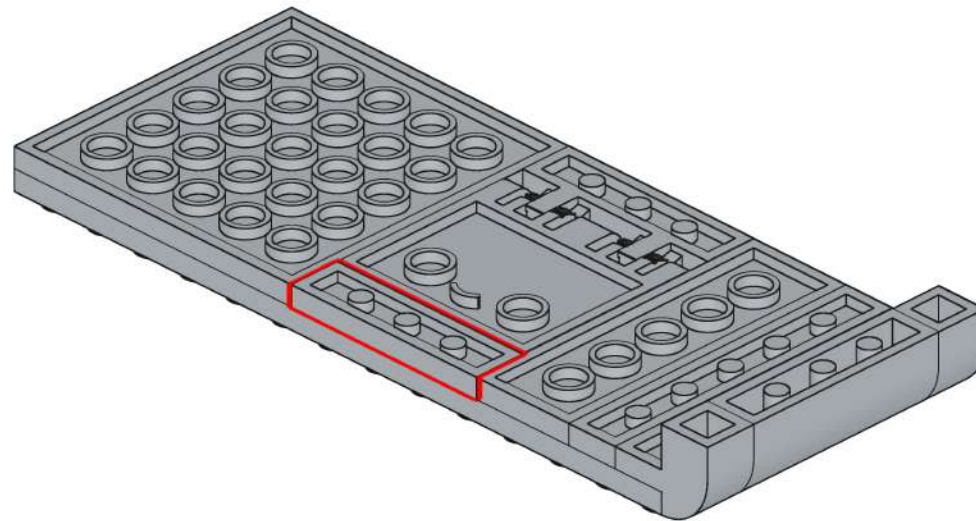
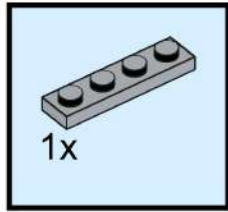

52

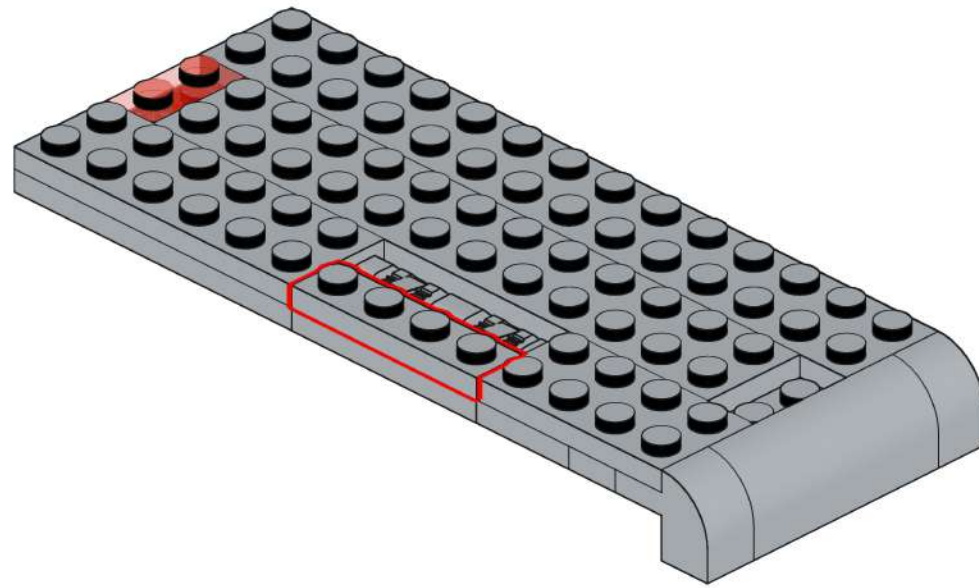
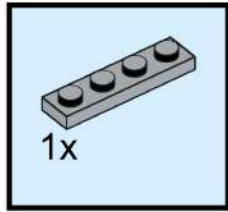

53

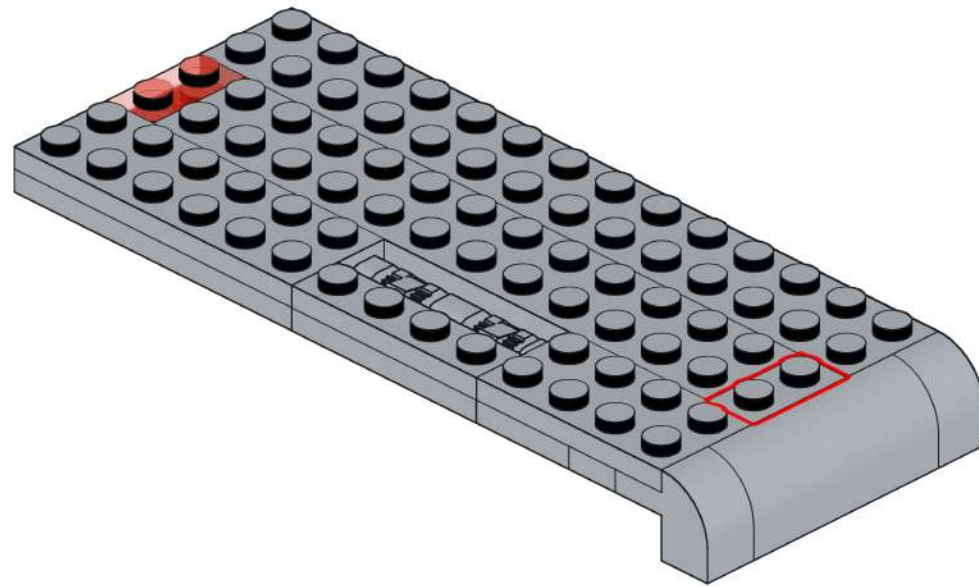
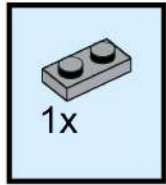

54

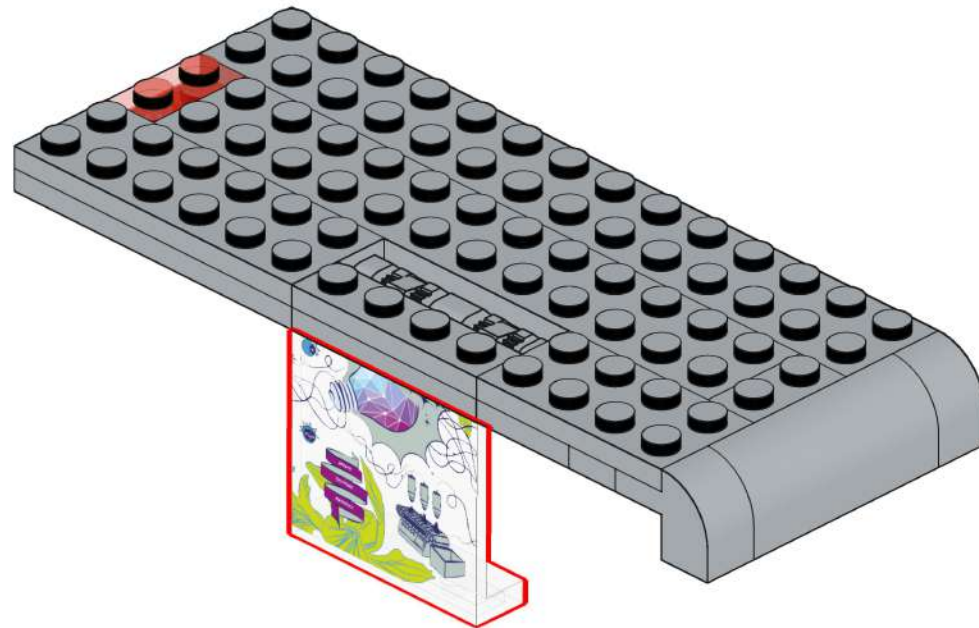
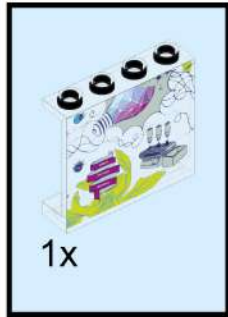

55

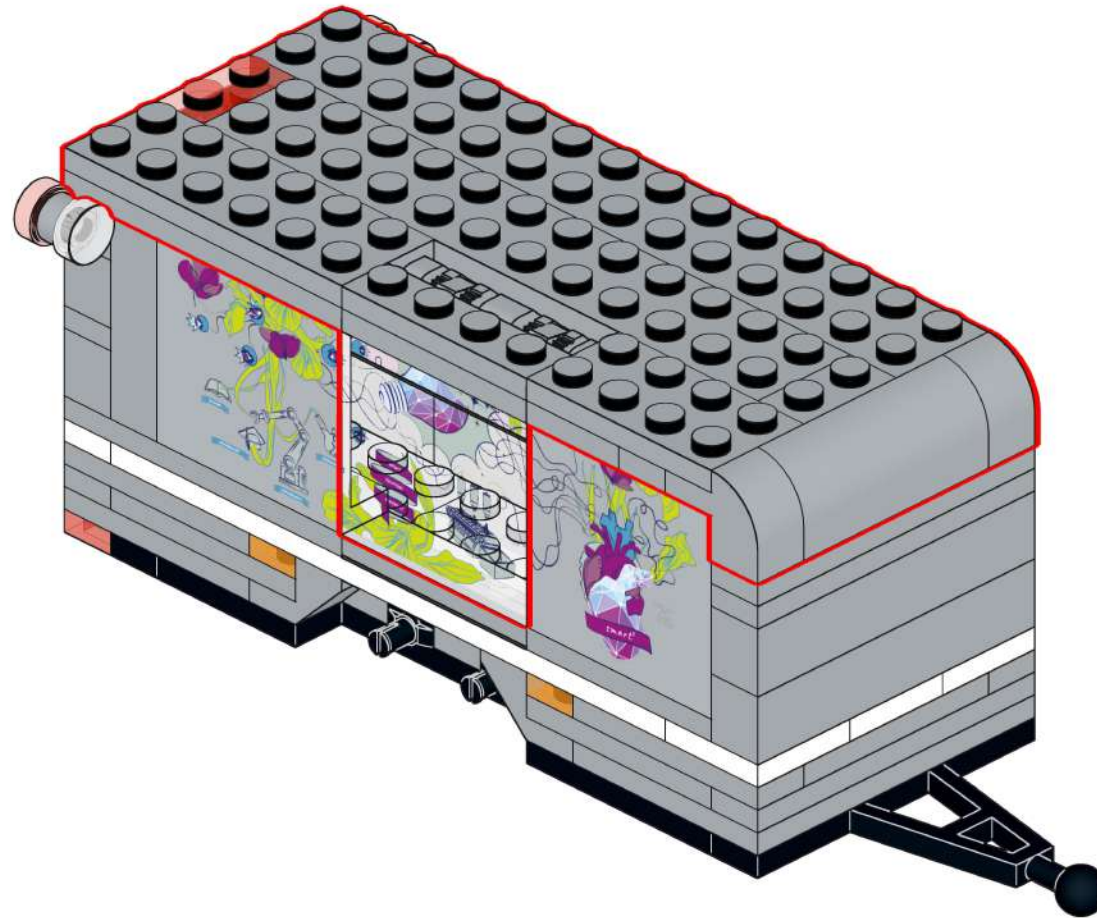

56

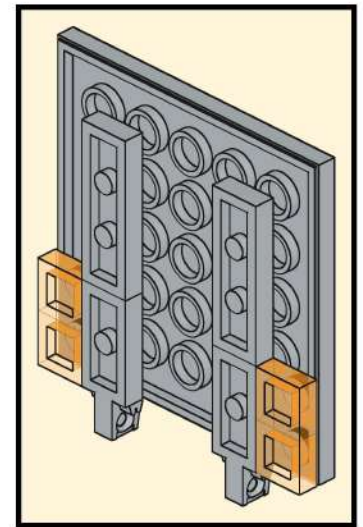
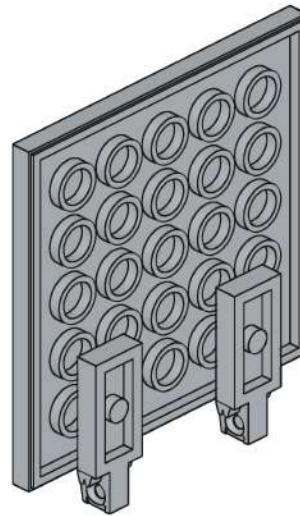
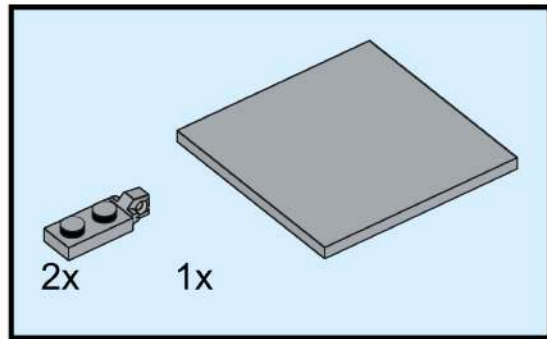

57

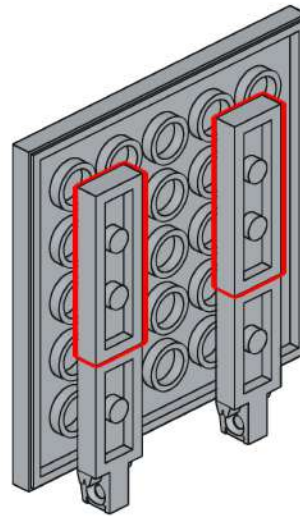
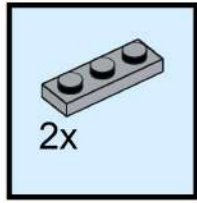

58

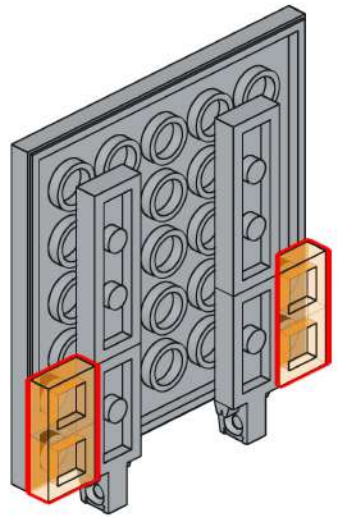
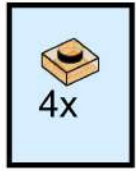

59

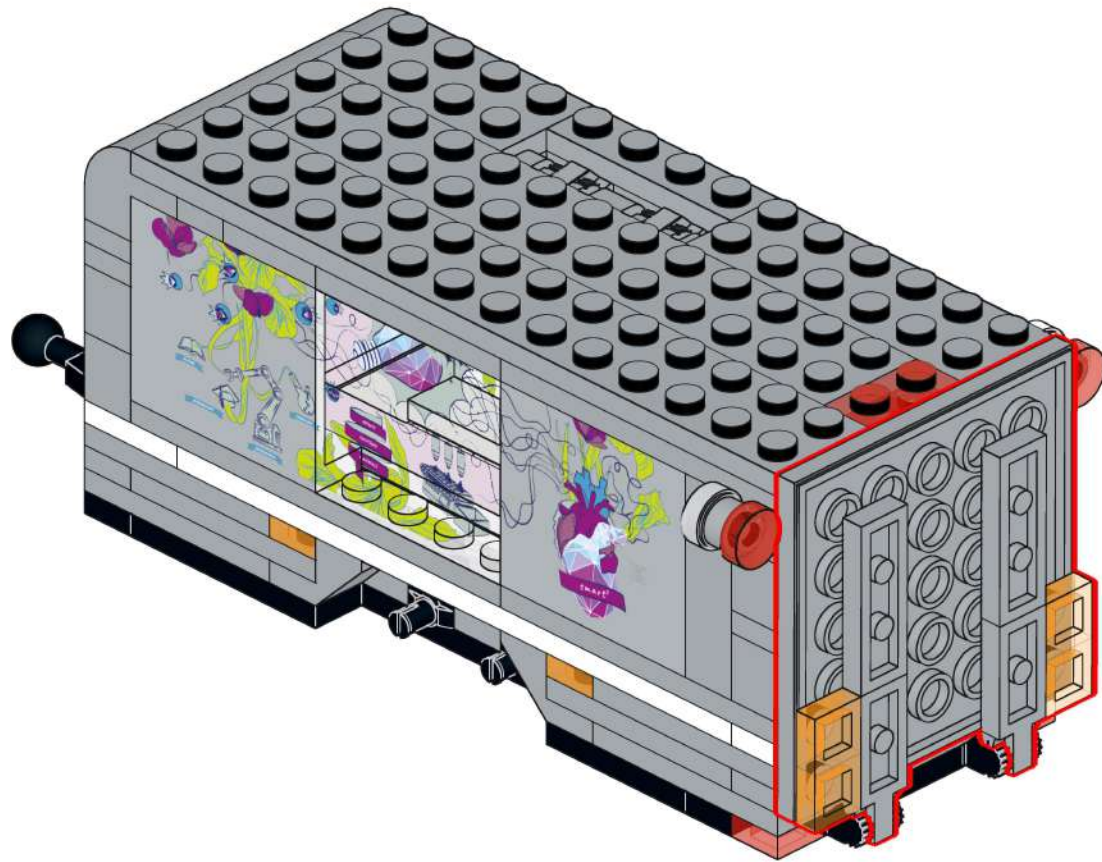

60

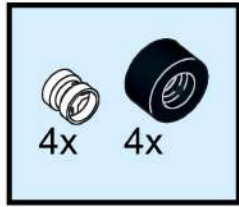

Europas größtes Netzwerk für smart materials

Als interdisziplinäres Netzwerk lebt smart³ den Austausch von Wissen und die Zusammenarbeit von Partnern unterschiedlicher fachlicher Herkunft. Sowohl in unserer Geschäftsstelle in Dresden als auch in unserer Zweigstelle in Saarbrücken initiieren wir Vernetzung, koordinieren damit zusammenhängende Aktivitäten und sind erster Anlaufpunkt für alle Mitglieder und an smart materials Interessierte. Und natürlich stehen wir Ihnen bei allen Fragen zu den Werkstoffen tatkräftig zur Seite.

Geschäftsstelle Dresden

Fraunhofer IWU
c/o smart3 e.V.
Nöthnitzer Str. 44
01187 Dresden

Zweigstelle Saarbrücken

ZeMA
c/o smart3 e.V.
Eschberger Weg 46
66121 Saarbrücken

smarthoch3.de



Bei diesem Set aus Original LEGO®-Steinen handelt es sich um ein MOC (My Own Creation). smart³ steht in keinerlei geschäftlicher Beziehung zu LEGO und wird nicht von diesem unterstützt. Der Weiterverkauf dieses Sets sowie die Weitergabe der Bauanleitung ist ohne ausdrückliche vorherige schriftliche Genehmigung durch smart³ untersagt.